

HPSB series power supply unit



Buffer, switch mode power supply unit 27,6V DC

EN**

CODE: **HPSB 5524C** v.1.0/VII
TYPE: **HPSB 27,6V/5A/2x17Ah Buffer, switch mode power supply unit**



GREEN POWER

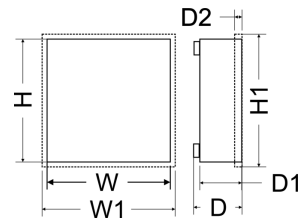

Features:

- DC 27,6V/5A uninterruptible power supply*
- fitting battery: 2x17Ah/12V
- wide range of mains supply: 176÷264V
- high efficiency 83%
- battery charging and maintenance control
- excessive discharging (UVP) protection
- jumper selectable battery charge current 0,5A/2A
- battery output full protection against short-circuit and reverse polarity connection
- LED indication
- protections:
 - SCP short-circuit protection
 - OVP overvoltage protection
 - overvoltage protection (AC input)
 - against sabotage
 - overload protection (OLP)
- warranty – 2 year from the production date

DESCRIPTION

A buffer PSU is intended for an uninterrupted supply to devices requiring stabilised voltage of **24V DC (+/-15%)**. The PSU provides voltage of **U=27,6V DC**. Current efficiency:

1. Output current **5A + 0,5A battery charge***
2. Output current **3,5A + 2A battery charge***

Total device current + battery: 5,5A max*.

In case of power decay, a battery back-up is activated immediately. The PSU is constructed based on the switch mode PSU, with high energy efficiency. The PSU is housed in a metal enclosure (colour RAL 9003) which can accommodate two 17Ah/12V batteries. A micro switch indicates door opening (front cover).

* Refer to chart 1

HPSB series power supply unit

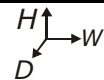

Buffer, switch mode power supply unit 27,6V DC

SPECIFICATIONS	
PSU type	A (EPS - External Power Source)
Mains supply	176÷264V AC 50÷60Hz
Current up to	1,4A@230VAC
Supply power	155W max.
Efficiency	83%
Output voltage	27,6V DC – buffer operation 19V÷27,6V DC – battery-assisted operation
Output current $t_{AMB}<30^{\circ}\text{C}$	5A + 0,5A battery charge - refer to chart 1 3,5A + 2A battery charge - refer to chart 1
Output current $t_{AMB}=40^{\circ}\text{C}$	3,3A + 0,5A battery charge - refer to chart 1 1,8A + 2A battery charge - refer to chart 1
Voltage adjustment range	24÷28VDC
Ripple	150mV p-p max.
Battery charge current	0,5A / 2A max. @ 2x 17Ah ($\pm 5\%$) – jumper selectable
Short-circuit protection SCP	electronic, automatic return
Overload protection OLP	105-150% of the PSU power, automatic return
Battery circuit protection SCP and reverse polarity connection	PTC polymer fuse
Surge protection	varistors
Overvoltage protection OVP	>32V (activation requires disconnecting the load or supply for about 20 s.)
Excessive discharge protection UVP	$U<19\text{V}$ ($\pm 5\%$) – disconnect of connection battery
Sabotage protection: - TAMPER output indicating enclosure opening	- microswitch, NC contacts (enclosure closed), 0,5A@50V DC (max.)
LED indication	Yes
Operating conditions	2nd environmental class, $-10^{\circ}\text{C}\div 40^{\circ}\text{C}$
Enclosure	Steel plate DC01, thickness: 0,7mm, colour: RAL 9003
Enclosure dimensions	400 x 350 x 90+8 [mm] (WxHxD)
Net/gross weight	3,5 / 3,8 kg
Fitting battery	2x17Ah/12V (SLA) max. 360 x 170 x 85mm (WxHxD) max 
Closing:	Cheese head screw x 2 (at the front), (lock assembly possible)
Declarations, warranty	CE, RoHS, 2 year from the production date
Notes	The enclosure does not adjoin the assembly surface so that cables can be led. Convectional cooling. Connectors: Power-supply: $\Phi 0,63\div 2,5$ Battery output BAT: 6,3F-2,5.

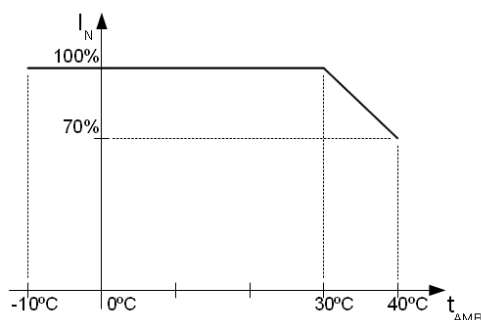

CHART 1. Acceptable output current from the PSU depending on ambient temperature.

HPSB series power supply unit



Buffer, switch mode power supply unit 27,6V DC

Optional configurations:

Buffer power supply unit HPSB 27,6V/5x1A/2x17Ah.

- HPSB5524C + LB8 5x1A (AWZ579 or AWZ580) + 2x17Ah

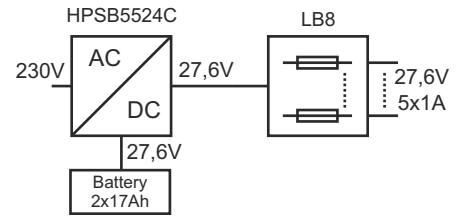

Buffer power supply unit HPSB 27,6V/10x0,5A/2x17Ah.

- HPSB5524C + 2xLB8 10x0,5A (AWZ578 or AWZ580) + 2x17Ah

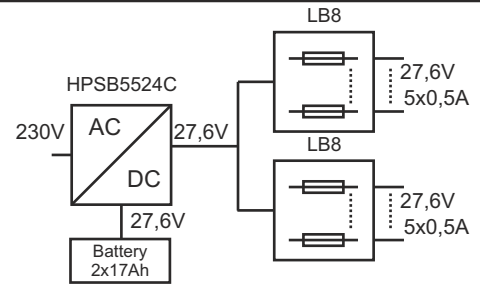

Buffer power supply unit HPSB 27,6V/16x0,3A/2x17Ah.

- HPSB5524C + 2xLB8 16x0,3A (AWZ577 or AWZ580) + 2x17Ah

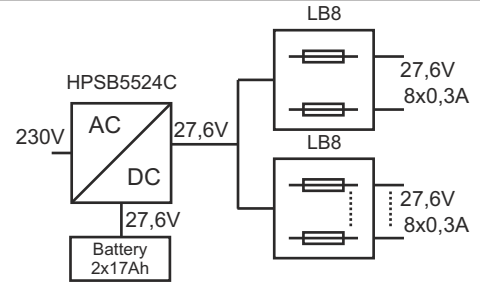

Buffer power supply unit HPSB 27,6V/2x24V/2x2,5A/2x17Ah.

- HPSB5524C + 2 x RN25024(27,6V/24V) + 2x17Ah

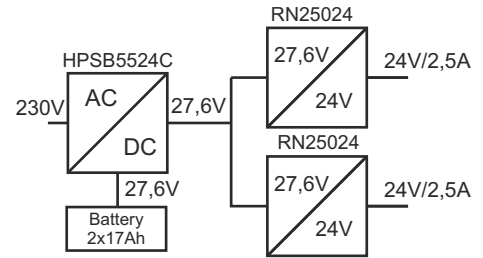

Buffer power supply unit HPSB 27,6V/2x24V/8x0,5A/2x17Ah.

- HPSB5524C + 2 x RN25024(27,6V/24V) + 2xLB4 8x0,5A (AWZ574 or AWZ576) + 2x17Ah

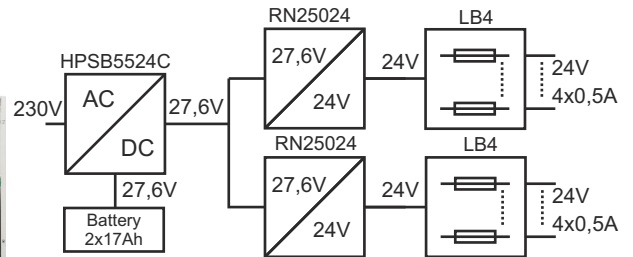

HPSB series power supply unit



Buffer, switch mode power supply unit 27,6V DC

Optional configurations:

Buffer power supply unit HPSB 27,6V/2x24V/10x0,5A/2x17Ah.

- HPSB5524C + 2 x RN25024(27,6V/24V)
- + 2xLB8 10x0,5A (AWZ578 or AWZ580) + 2x17Ah

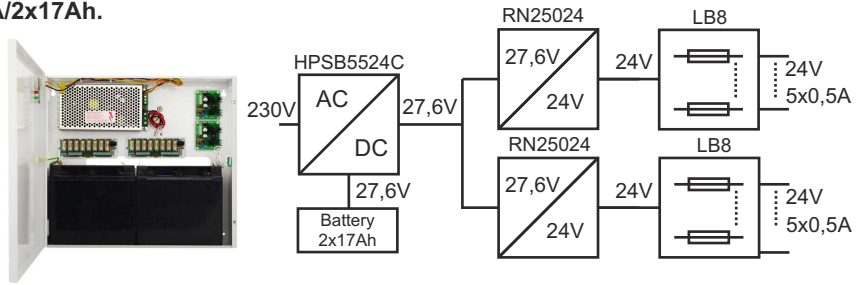

Buffer power supply unit HPSB 27,6V/2x24V/16x0,3A/2x17Ah.

- HPSB5524C + 2 x RN25024(27,6V/24V) +
- 2xLB8 16x0,3A (AWZ577 or AWZ580) + 2x17 Ah

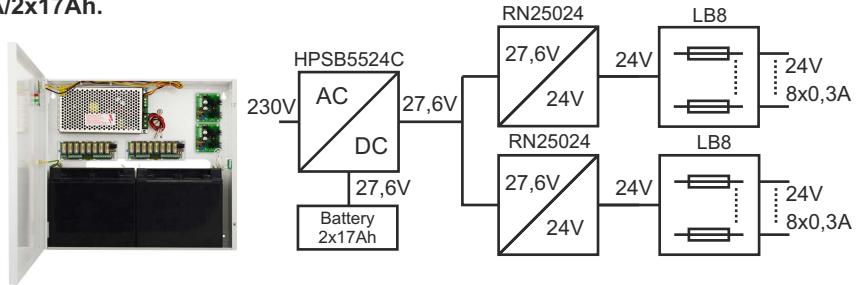

Buffer power supply unit HPSB 27,6V/3x5V÷18V/3x2A÷1,3A/2x17Ah.

- HPSB5524C + 3xDCDC20 (3x5V÷18V) + 2x17Ah

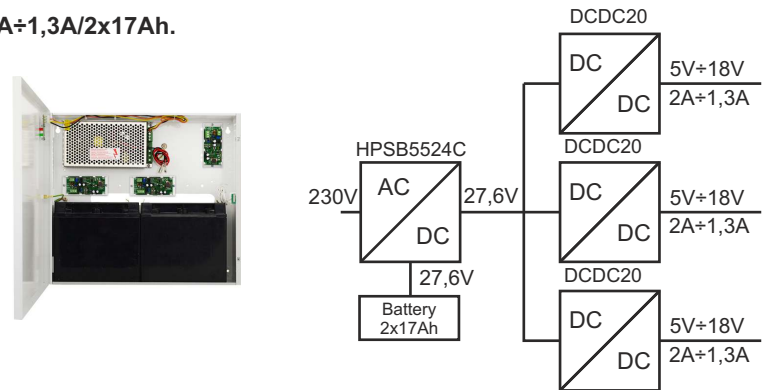

Buffer power supply unit HPSB 27,6V/3x5V÷18V/3x2A÷1,3A/12x0,5A/2x17Ah.

- HPSB5524C + 3xDCDC20 (3x5V÷18V) + 3xLB4
- 12x0,5A (AWZ574 or AWZ576) + 2x17Ah

