

IQ PANEL 4

INSTALLATION MANUAL

IQ Panel 4
Software Version 4.2.0

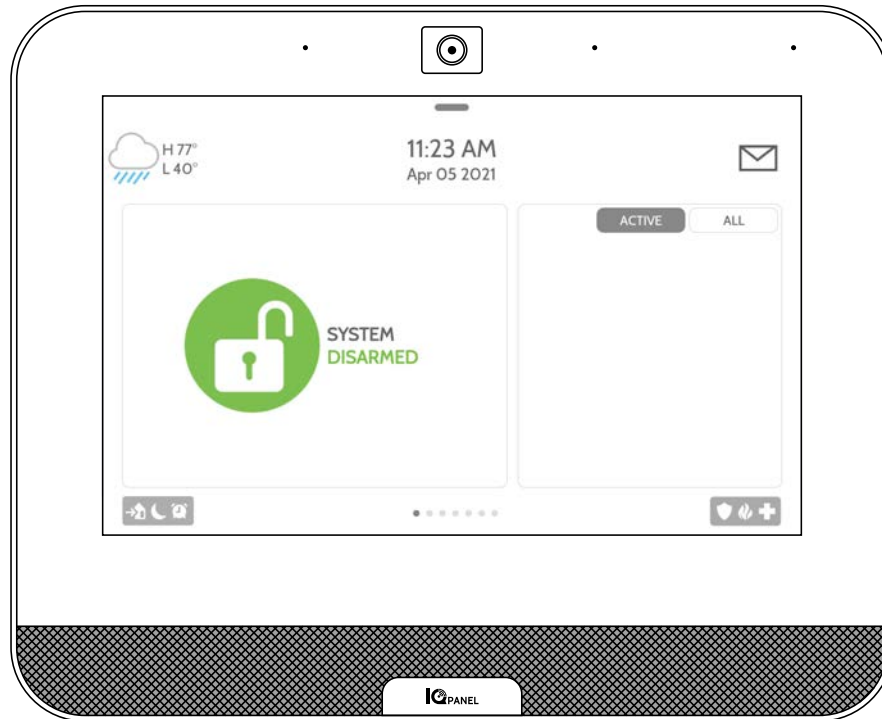

The IQ Panel 4 is an All-In-One 7" (17.8cm) touchscreen built with a built-in camera, providing full security and smart home functionality in an easy to use interface.

INCLUDED IN BOX

IQ Panel 4

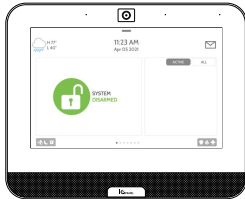

Power
Supply

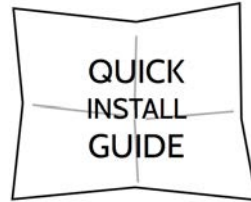
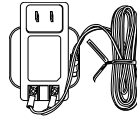

ABOUT THIS GUIDE

This document outlines the basic hardware specifications and software directions to install and customize the IQ Panel 4. Note that the information presented is not comprehensive, but is specifically dedicated to those menus, features, and systems accessible solely to those with the proper installation code. Features accessible to users and installers alike are outlined in the IQ Panel 4 User Guide. In this document, reference to “EN Grade 2” refers to EN50131 Grade 2 Certified product. The information contained herein is proprietary, and is solely owned by Qolsys Inc. Any reproduction, modification or distribution without permission is strictly prohibited.

SUPPORT



QUESTIONS?

Contact us at
techsupport@qolsys.com

TABLE OF CONTENTS



PANEL OVERVIEW

- 5- Exterior Front
- 6- Exterior Back
- 7- Interior

INSTALLING THE PANEL

- 9- Wall Mount
- 10- Table Stand Option
- 11- IQ Base
- 12- Wiring Diagram
- 13- Powering the Panel

USER INTERFACE

- 16- Home Screen Overview
- 17- Message Center
- 18- Settings Tray

PROGRAMMING

- 20- Screen Lock
- 21- Settings
- 23- Advanced Settings
- 24- Setup Wizard
- 28- Installation
- 30- Installer/Dealer Settings
- 40- System Logs
- 41- Siren and Alarms
- 44- Security and Arming
- 48- Camera Settings
- 50- Z-Wave Device List
- 51- Sound
- 55- Partitions
- 56- Local Automation

SECURITY SENSORS

- 58- Security Sensors
- 60- Auto Learn Sensor
- 61- Add Sensor
- 62- Scan QR Code
- 63- Partition Name
- 64- Sensor Type
- 65- Sensor Groups
- 82- Sensor Name
- 84- Chime Type
- 85- Voice Prompts
- 86- Source
- 87- Edit Sensor
- 88- Delete Sensor
- 89- Sensor Status
- 91- Panel Motion Settings

WI-FI DEVICES

- 93- Wi-Fi Devices
- 96- Access Point Settings
- 97- AP Connected Devices
- 98- IQ Remote Devices
- 99- 3rd Party Connections
- 100- IQ WiFi

Z-WAVE™ DEVICES

- 102- Z-Wave Devices
- 103- Add Device
- 104- Clear Device
- 105- Delete Failed Device
- 106- Remove All Devices
- 107- View/Edit Associations
- 108- Z-Wave Settings
- 110- SmartStart
- 111- Provisioning List

BLUETOOTH DEVICES

- 113- Bluetooth Devices
- 114- Add Phone
- 115- Edit Device
- 116- Delete Device
- 117- Remove All Devices
- 118- Settings

SYSTEM TESTS

- 120- System Tests
- 122- Wi-Fi Test
- 123- Sensor Test
- 126- Cellular Test
- 127- Z-Wave Test
- 128- Rediscover Network
- 129- Neighbor Info
- 130- Counters
- 132- Z-Wave Diagnostics
- 133- Advanced Z-Wave Diag
- 134- PowerG Test
- 135- PowerG Signal Strength
- 136- Zigbee Test
- 137- Panel Glass Break Test
- 140- Dual Path Test
- 141- Daughter Cards Test
- 142- Panel Test
- 143- Ambient Noise Test
- 144- Input Voltage Test

CUSTOMIZATION

- 146- User Management
- 147- Dealer Branding
- 148- Contact Info
- 149- On-Screen Branding

- 150- Connecting to Wi-Fi
- 151- Weather
- 152- Photo Frame

MAINTENANCE

- 156- Upgrade Software
- 157- Upgrade Software Using Wi-Fi
- 158- Upgrade Software Using Panel AP
- 159- Automatic Background Check
- 160- Battery Replacement

TROUBLESHOOTING

- 163- About
- 166- Power Down
- 167- Panel Reboot
- 168- Hard Reboot
- 169- Panel Test Troubleshooting

LEGAL

- 172- Important Information

SPECIFICATIONS

- 189- Specifications North America
- 191- Supported 319 MHz S-Line Sensors
- 192- Supported 345 MHz Sensors
- 193- Supported 433 MHz (DSC) Sensors
- 194- Supported 433 MHz (AT&T) Sensors
- 195- Supported PowerG Sensors
- 196- Supported Zigbee Sensors
- 197- Specifications Europe & UK
- 199- Supported PowerG Sensors EU & UK
- 200- Supported 433 Sensors Iceland
- 201- Specifications Latin America
- 203- Supported PowerG Sensors LatAM

PANEL OVERVIEW

For US and CANADA: Warning: This Product should be installed in accordance with the National Fire Alarm Code, ANSI/NFPA 72, (National Fire Protection Association, Batterymarch Park, Quincy, MA 02269) and with National Electric Code, ANSI/NFPA 70. Printed information describing proper installation, operation, testing, maintenance, evacuation planning, and repair service is to be provided with this Product. In Canada the product shall be installed in accordance with the Standard for the Installation of Residential Fire Warning Systems, CAN/ULC-S540.

Warning: For Canadian installations this Product and all sensors associated with it (collectively, the "System") should be tested once a week. The test shall be performed also with primary DC power de-energized. For recommended smoke detectors maintenance instructions refer to user manual associated with compatible Qolsys model Q55110-840 and PowerG model PG9936 smoke detectors.

For All Countries: Warning: This Product should be installed in accordance with the National and Local Fire Codes and National and Local Electrical Codes. Printed information describing proper installation, operation, testing, maintenance, evacuation planning, repair service, recycling and disposal is to be provided with this Product. Warning: For all installations this Product and all sensors associated with it (collectively, the "System") should be tested once a week. The test shall be performed also with primary DC power de-energized. For all Sensors, Detectors, and other accessories, follow the recommended maintenance instructions for each device.

EXTERIOR FRONT

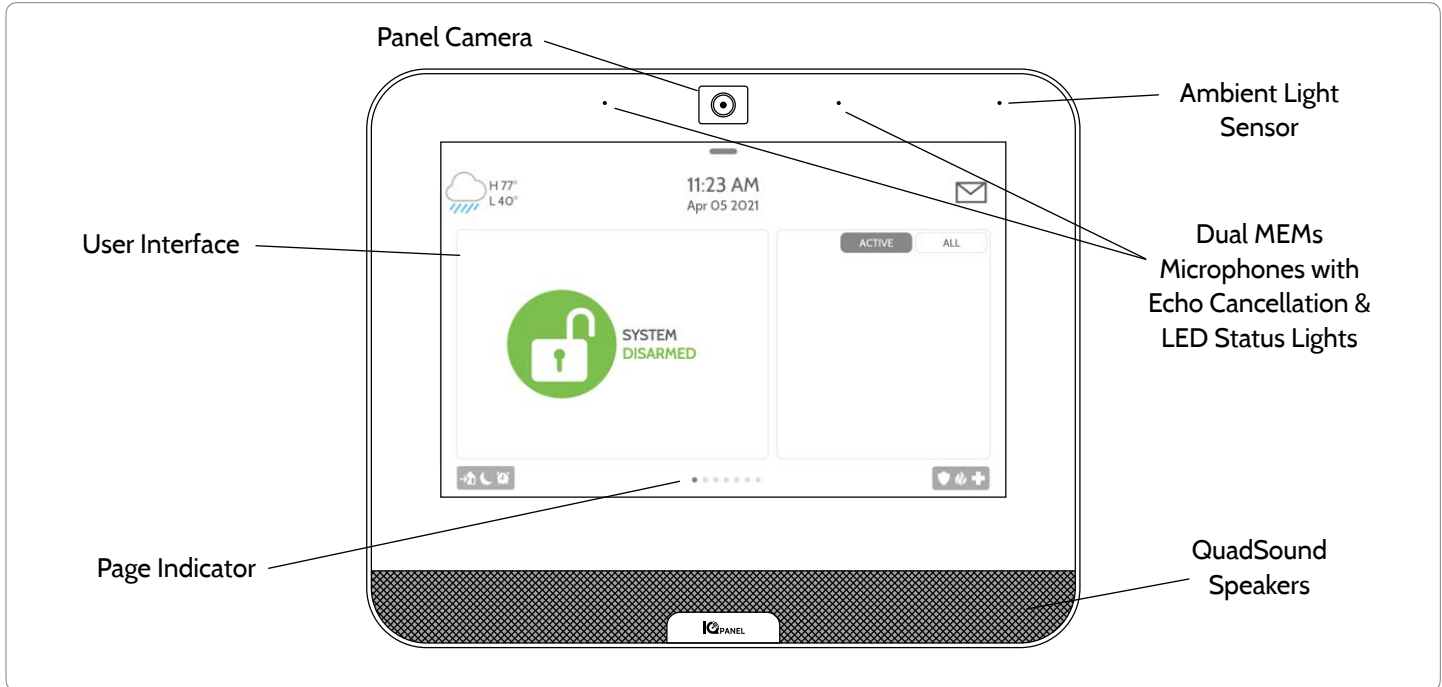

EXTERIOR BACK

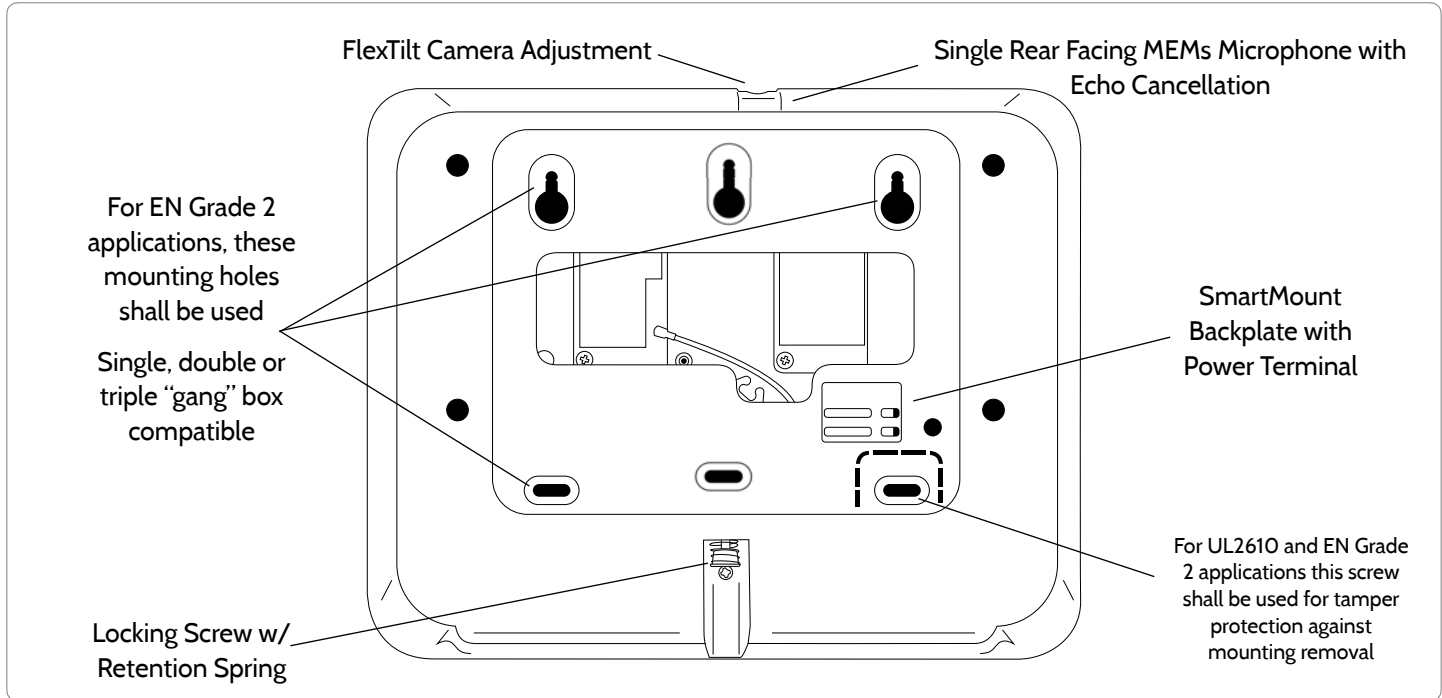

INTERIOR

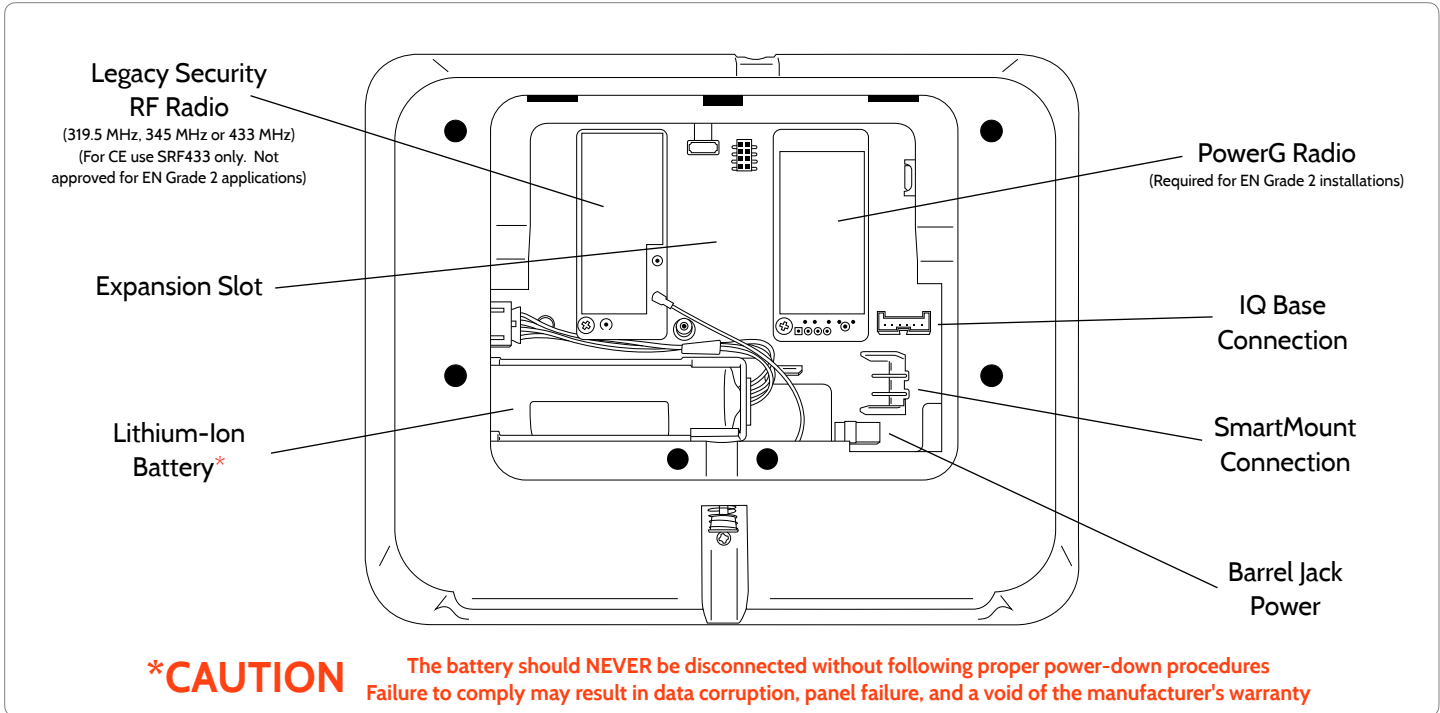

INSTALLING THE PANEL

INSTALLING THE PANEL

WALL MOUNT

Note: For UL/ULC Commercial Burg installations (UL2610/ULC-S304 Security Level II compliant) and EN Grade 2 installations use only wall mount option

This product when installed as per these instructions does not present the risk of fire, electric shock, or injury to persons.

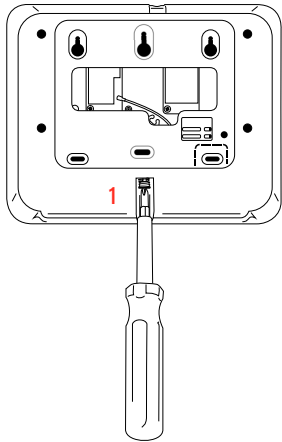

1. With a small phillips screwdriver, undo the locking screw from the back of the panel and remove the SmartMount backplate.

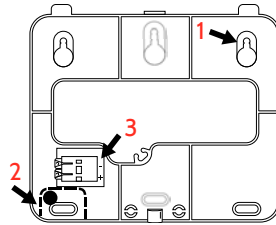

1. Mount the backplate to the wall using flat head screws* and appropriate wall anchors if needed, ensuring it is level.

2. A screw is required in break-away wall tamper for UL 2610 and EN Grade 2 installations.

3. Connect the power supply to the barrel jack on the back of the panel or to the (+) and (-) terminals on the backplate if using a custom length wire.

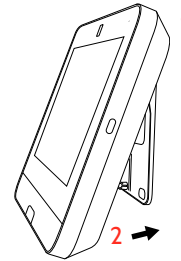

1. Latch the top of the IQ Panel 4 onto the SmartMount backplate.

2. Swing the panel down towards the backplate and press firmly against the wall.

If using a custom length wire, power terminals will automatically connect and provide power to the IQ Panel.

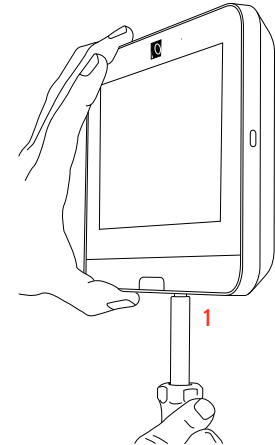

1. With a small phillips screwdriver, screw in the locking screw from the bottom of the panel to secure it to the wall.

*Screws shall be a minimum of 1" in length (25.4mm), size #6 (M3.5)

TABLE STAND (OPTIONAL)

Do not use for UL2610 or EN Grade 2 or equivalent installations

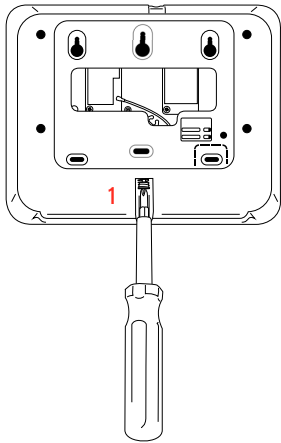

1. With a small Phillips screwdriver, undo the locking screw from the back of the panel, remove the SmartMount backplate and discard.

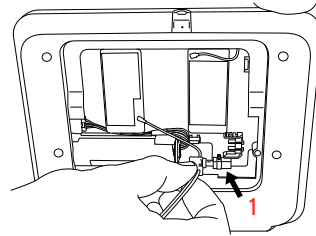

1. With the included power supply and cable, plug the barrel connector into the barrel jack as shown above.

Be sure the barrel connector is properly seated.

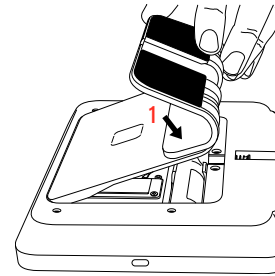

1. Locate the SmartMount table stand and insert the hooks into the back of the panel, then swing down and press into place.

Be sure that the power wire is routed out the middle of the table stand using the provided slot.

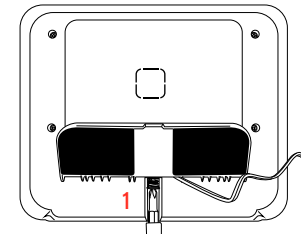

1. With a small Phillips screwdriver, screw in the locking screw from the bottom of the panel to secure it to the table stand.

IQ BASE SPEAKER (OPTIONAL)

Do not use for UL2610 or EN Grade 2 or equivalent installations

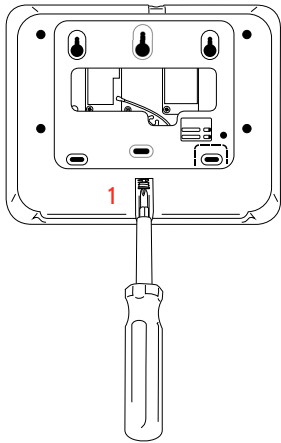

1. With a small Phillips screwdriver, undo the locking screw from the back of the panel, remove the SmartMount backplate and discard.

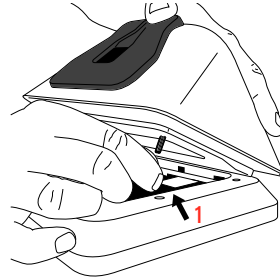

1. Locate the IQ Base with SmartMount and connect the power cable from the IQ Base into the **BLACK** connector inside the IQ Panel 4. Refer to Interior Diagram on Page 7

Insert the top hooks into the back of the panel, then swing down and press into place.

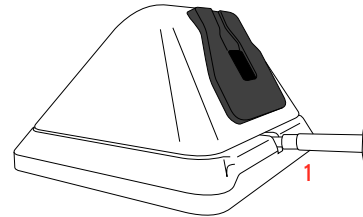

1. With a small Phillips screwdriver, screw in the locking screw from the bottom of the panel to secure it to the IQ Base.

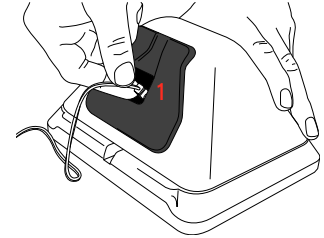

1. With the included power supply and cable, plug the barrel connector into the barrel jack on the bottom of the IQ Base as shown above.

Be sure the barrel is pushed all the way in.

WIRING DIAGRAM

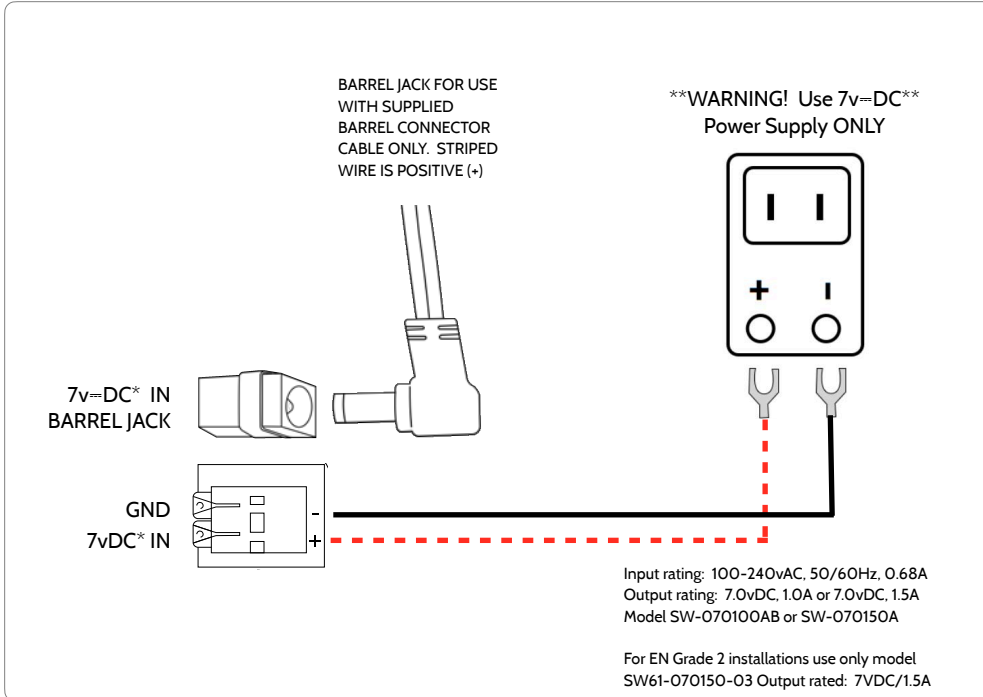

NOTES

IMPORTANT IF USING CUSTOM LENGTH WIRE:

- 7v=DC Transformer: Use 18AWG (0.75mm²) wire no longer than 98.5ft (30m) to ensure sufficient power is received at the panel.

* The minimum permissible wire size shall not be smaller than 22 AWG (0.33mm²)

** 7v=DC power supply output shall not exceed 15VA (15W) under any conditions

POWERING THE PANEL

Note: This unit must be powered by a 24-hour, 120 V, 60 Hz or 230-240 VAC, 50 Hz circuit (as appropriate for your country) that cannot be turned off by a switch, dimmer, or Residual Current Device. Failure to provide this circuit may prevent it from providing constant protection. Power supply shall be located within same room as control unit.

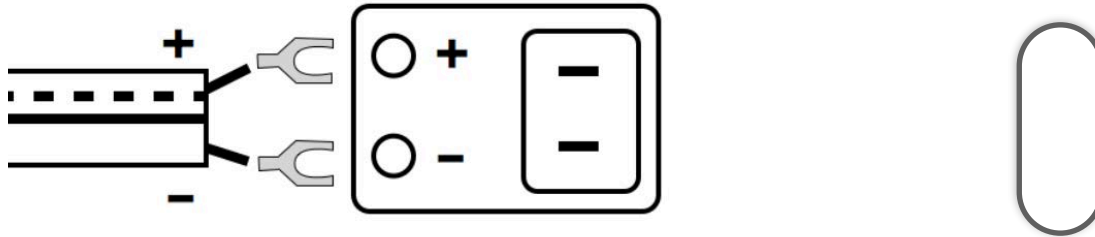

Connect power supply.

WARNING! Use **included 7v=DC** Power Supply **ONLY**

If using the provided cable, the “striped” wire is (+)

Note: Power supply shall be located within same room as control unit

Press and hold the power button on the right side of the panel for 3 seconds to power up.

FLEXTILT CAMERA ADJUSTMENT

FlexTilt camera adjustment allows the built-in Panel Camera to be angled up or down depending on the installation need. This is especially helpful when wall mounting over an existing keypad location that may be higher or lower than usual, or when table stand mounting.

1. Use a small phillips screw driver to adjust the FlexTilt screw on the top of the Panel to achieve the desired camera angle.

NOTE: Turning the screw clockwise angles the camera down. Turning the screw counter-clockwise angles the camera up.

2. Arm/Disarm the Panel to capture a Disarm Photo and test the FlexTilt position. Adjust as needed.

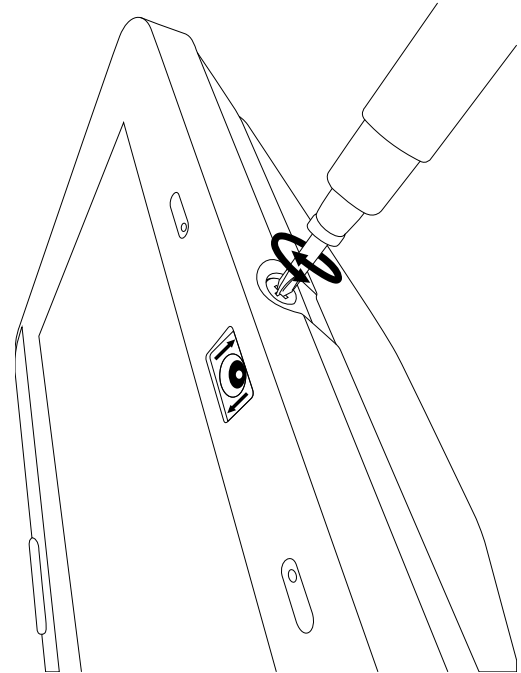

USER INTERFACE

HOME SCREEN OVERVIEW

The home screen is divided into three sections. The header shows the date & time, today's weather, message center and the Settings tray. The Primary interface shows arming options and sensor status & partition select. The footer shows panic options and additional pages.

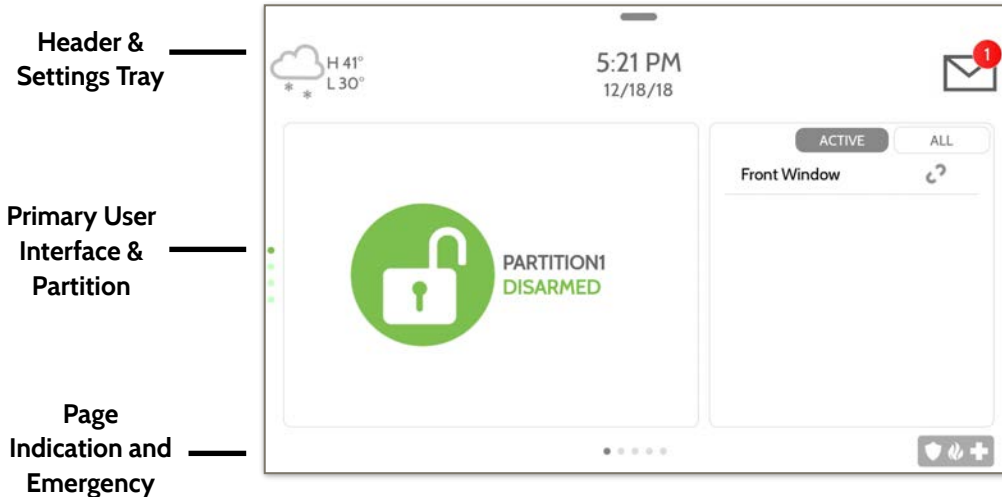

MESSAGE CENTER

The header contains the pull down settings tray, the weather icon, time/date and a message icon in the upper right portion of the screen where you will find Security Provider messages and contact info, alerts, video tutorials and FAQ's



11:18 AM
09/15/16



CONTACT US

This is where you will find the Security Provider's Contact Information

VIDEO TUTORIALS

This is where you will find Video Tutorials to help with common questions

ALERTS/ALARMS ¹

This is where you will find Panel Alerts/Alarms notifications

MESSAGES

This is where you will find messages from the Security Provider

SETTINGS TRAY

To access the Settings tray swipe down on the bar at the top of the screen. The Settings tray has quick access to system, battery, Wi-Fi, Bluetooth & cellular status as well as volume control, brightness, a lock screen icon and other quick settings.



FIND IT

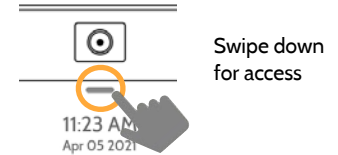

When partitions or screen lock are ENABLED, a Lock Screen icon replaces the Status icon. Touch this icon to switch between partitions.

When partitions are DISABLED, a Status icon resides in the upper left corner of the settings tray. Touch this icon to return to the security page.

PROGRAMMING

SCREEN LOCK

Note: This feature has not been evaluated for EN Grade 2

When the “Screen Lock” or “Partitions” setting are enabled, a lock screen will be presented once the panel has been woken from either a touch on the screen or pressing the wake/sleep button on the side of the panel. This prevents unauthorized access to the panel and/or one partition from accessing another as well as managing permissions to “Advanced Settings”. Screen lock may also be turned off if desired, even when Partitions are enabled.

4 DIGIT SCREEN LOCK

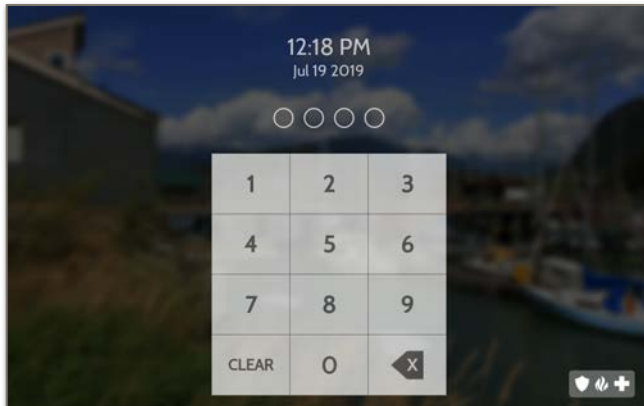

6 DIGIT SCREEN LOCK

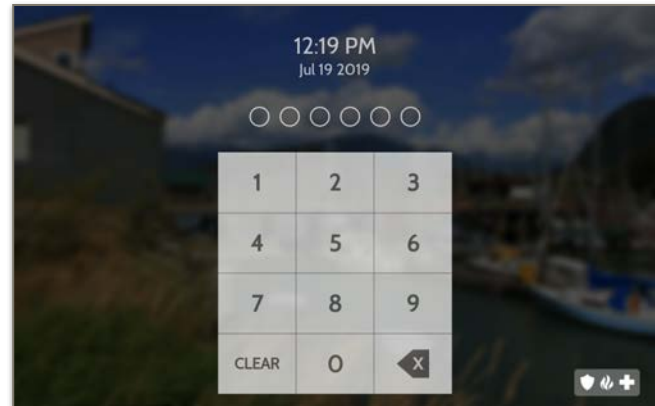

SETTINGS

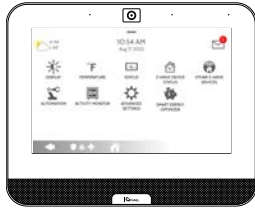

The Settings page allows quick access to various simple features & settings that do not require the protection of a Dealer, Installer or Master code to be changed.

Setting	Description
Display	Adjust brightness, font size & 12/24 hour time as well as adaptive brightness or night light mode. You can also enable the Status LED slider.
Weather Temperature	Toggle between Fahrenheit and Celsius
Status	View the "Current Status" of security sensors: Zone #, Name, Status (Open, Close, Active, Idle, Tamper, Failure), Battery and sensor History. Also view "Alarms" and "History" for security sensors globally
Z-Wave™ Device Status	View the "Current Status" of Z-Wave devices: Name, Type, Status (Normal, Failure), and Battery. Also view "Alerts" and "History" for Z-Wave globally
Other Z-Wave Devices	Shows Z-Wave devices that are learned into the panel but that are not part of the main user interface (Lights, Locks, Thermostats & Garage Doors)

FIND IT

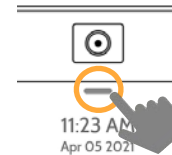

Swipe down for access



SETTINGS

Setting	Description
EU Events	Display events as required for EN Grade 2. NOTE: This icon will only appear when the "En Grade 2" setting is Enabled.
Automation	<p>Add, Edit or manage local lighting automation rules. These rules are separate from any cloud based rules that may be set through Alarm.com. Examples of possible rules are as follows:</p> <ul style="list-style-type: none"> - Night: Turns light on at 7pm and off at 6am - Evening: Turns light on at 7pm and off at 11pm - Front Door: Turns light on for 15mins when Front Door opens between 5pm and 7am (must have a sensor with the default quick name "Front Door" added in the panel) - Doorbell: Turns light on between 5pm and 7am for 15 mins when Doorbell is activated (must have a sensor with the default quick name "Doorbell" added in the panel)
Activity Monitor	<p>Activity Monitor allows access to disarm sensors that are programmed as 24 hours zones, such as Sensor Groups 8, 9 & 25. A valid Master, User or Guest code is required to control 24 hour activity sensors. 2 options are provided:</p> <ul style="list-style-type: none"> - Quick Access: 300 second temporary access - Deactivate: Disarms 24 hour sensors until they are re-activated manually
License	Qolsys End User License Agreement
Advanced Settings	Access advanced settings & programming. A valid Dealer (default 2222), Installer (default 1111) or Master Code (default 1234) is required
Smart Energy Optimizer	Shift energy usage to off-peak hours (thermostats) and reduce energy usage during on-peak hours

ADVANCED SETTINGS



To access the Advanced Settings menu pull down the Settings tray at the top of the screen, select “Settings” and then “Advanced Settings”. Enter your dealer, installer or master code. The code used to enter Advanced Settings determines the level of access. When using partitions the code entered at the screen lock determines the access level for Advanced Settings.

INSTALLER MENU (1111)



DEALER MENU (2222)



FIND IT

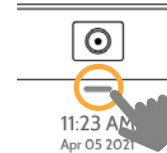

Swipe down for access



SETTINGS



ADVANCED SETTINGS



ENTER CODE (1111, 2222)

* The “Partitions” icon will only appear if Partitions are enabled under Installer/Dealer Settings

SETUP WIZARD



Setup Wizard

The “Easy Install Wizard” is an onscreen, step-by-step programming tool that makes the already fast and intuitive installation process even easier, ensuring every install is consistent and follows best practices.



Launch Wizard

Selecting Launch Wizard will initiate the Easy Setup Wizard based on the page configuration chosen.



Wizard Settings

Choose which pages you want to be shown during the Wizard walkthrough. Select Advanced or Simple sensor setup.

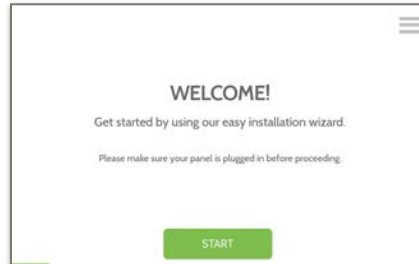

FIND IT

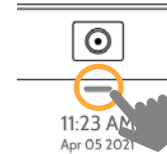

Swipe down for access



SETTINGS



ADVANCED SETTINGS



ENTER CODE (1111, 2222)



SETUP WIZARD

LAUNCH WIZARD



Launch Wizard



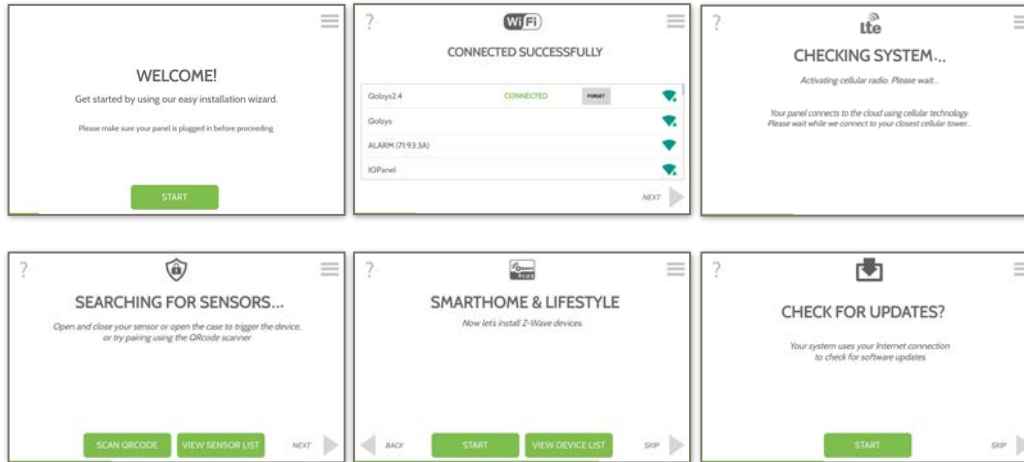

Selecting Launch Wizard will initiate the Easy Setup Wizard based on the page configuration chosen in Wizard Settings.

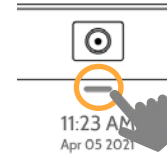

FIND IT



Swipe down
for access

-  **SETTINGS**
-  **ADVANCED SETTINGS**
-  **ENTER CODE (1111, 2222)**
-  **SETUP WIZARD**
-  **LAUNCH WIZARD**

WIZARD SETTINGS



Wizard Settings

Choose which pages you want to be shown during the Wizard walkthrough.
Select Advanced or Simple sensor setup

Setting	Default	Description
Update	Enabled	Show the option to check for software updates in the Setup Wizard
Security	Enabled	Show the option to add and edit security sensors in the Setup Wizard
Security Sensor Setup Format	Advanced	Determines whether the Security page of the Setup Wizard shows Advanced Sensor pairing (PRO) or Simple Sensor pairing (DIY)
Panel Glass Break	Enabled	Show the option to enable or disable the panel glass break in the Setup Wizard. NOTE: Not approved for UKCA or CE/EN Grade 2
Z-Wave	Enabled	Show the option to include and edit Z-Wave devices in the Setup Wizard
Bluetooth	Enabled	Show the option to pair Bluetooth devices in the Setup Wizard NOTE: Not approved for EN Grade 2

FIND IT

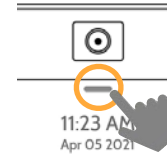

Swipe down for access



SETTINGS



ADVANCED SETTINGS



ENTER CODE (1111, 2222)



SETUP WIZARD



WIZARD SETTINGS

WIZARD SETTINGS

Setting	Default	Description
Users	Enabled	Show the option to add users in the Setup Wizard
Dealer	Enabled	Show the option to add and edit Dealer Contact Info in the Setup Wizard
IQ Remote	Enabled	Show the option to pair IQ Remotes in the Setup Wizard
Sensor Signal Test	Enabled	Activate the sensor test as part of the Setup Wizard
Download Mobile App	Enabled	Show the option to scan a QR code and download the Alarm.com app

FIND IT

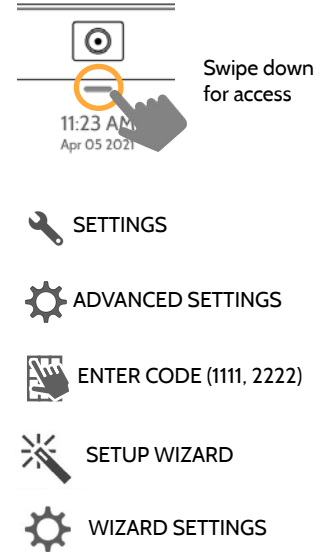

INSTALLATION

If Dealer Contact info is not previously filled out or pushed from Alarm.com, a pop up is generated when accessing the “Installation” icon, requiring that dealer contact information to be entered. This information is used to populate the “Contact Us” tab in the Message Center. **NOTE:** Company Name and Company Phone Number are required and must be filled out to continue with panel programming.

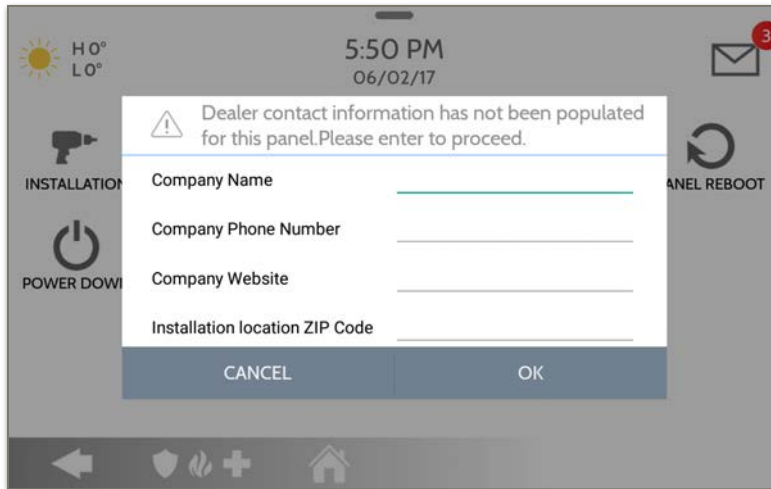

FIND IT

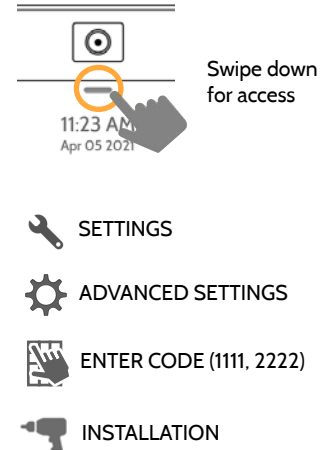

INSTALLATION

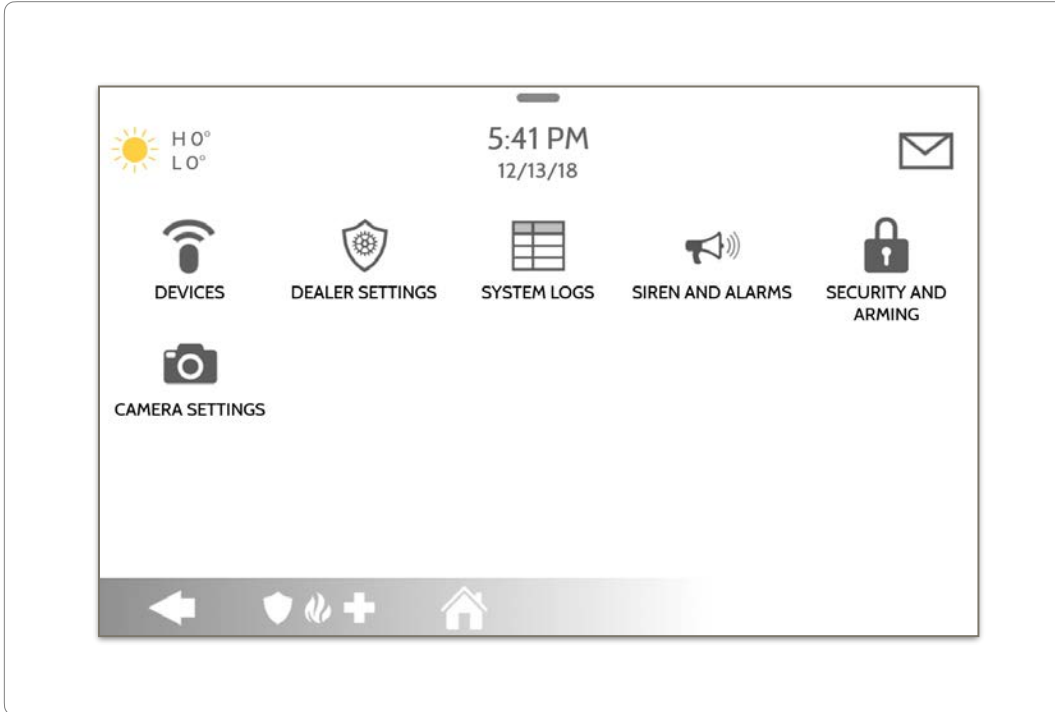

FIND IT

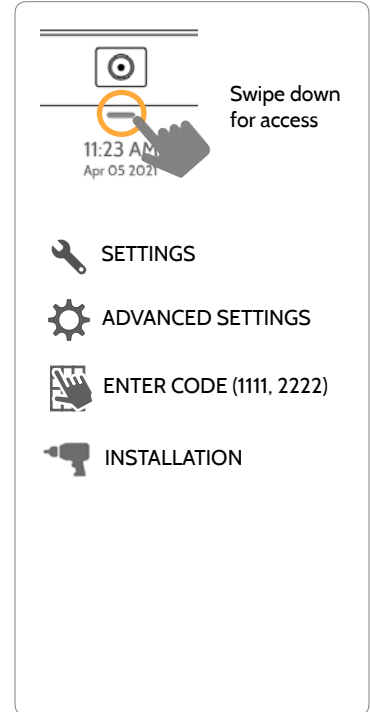

INSTALLER/DEALER SETTINGS



Installer/Dealer Settings

Change panel settings like supervisory times, power and cell loss timeout and SIA settings.

Setting	Default	Description
Account Number	blank	Security provider account number (up to 10 characters)
Power Management	Enabled	An energy-saving function when running on battery power only
SIA Power Restoration	Disabled	Turn on or off sensor hold for 60 seconds during power restore
ULC Commercial Power Restoration	Disabled	When enabled, ignore all sensor activity for 120 seconds after power restoration
Loss of Supervisory Signals for Emergency Sensors	4	Select the length in hours (4, 12, 24) before reporting a loss of supervision on life safety devices. NOTE: For UL/cUL Resi Fire and UL Commercial Burg (UL2610) the wireless supervision window for Emergency sensors (Smoke, Heat & CO Detectors) shall be set to 4h
Loss of Supervisory Signals for PowerG Emergency Sensors	4	Select the length of time (20, 30 min, 1, 2, 4, 12, 18 hours) before reporting a loss of supervision on PowerG life safety devices. NOTE: For UL/cUL Resi Fire and UL Commercial Burg (UL2610) the wireless supervision window for Emergency sensors (Smoke, Heat & CO Detectors) shall be set to 2h

FIND IT

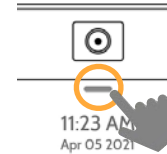

Swipe down for access



SETTINGS



ADVANCED SETTINGS



ENTER CODE (1111, 2222)



INSTALLATION



INSTALLER/DEALER SETTINGS

* Additional options available only through the Dealer Code.

INSTALLER/DEALER SETTINGS

Setting	Default	Description
Loss of Supervisory Signals for Z-Wave	4	Select the length in hours (4, 24) before reporting a loss of supervision on Z-Wave Sirens.
Loss of Supervisory Signals for Non Emergency Sensors	24	Select the length in hours (4, 12, 24) before reporting a loss of supervision on security devices. NOTE: For UL/cUL Resi Fire and UL Commercial Burg (UL2610) the wireless supervision window for Non-Emergency sensors (all intrusion sensors) shall be set to 4h. These devices shall not be used for EN Grade 2 compliant installations
Loss of Supervisory Signals for PowerG Non Emergency Sensors	24	Select the length of time (20, 30 min, 1, 2, 4, 12, 24 hours) before reporting a loss of supervision on PowerG security devices. NOTE: For UL/cUL Resi Fire and UL Commercial Burg (UL2610) the wireless supervision window for Non-Emergency sensors (all intrusion sensors) shall be set to 4h. For EN Grade 2, the supervision window shall be set for 20 minutes.
Loss of Cell Signal Timeout	30	Select the length in minutes (10-120) before reporting a loss in cellular signal. NOTE: For UL Commercial Burg (UL2610) the cell supervision is hardcoded to 200s
Communication Test	Monthly	Choose Never, Daily, Weekly or Monthly when enabling the communication test. NOTE: For UL Resi Fire (UL985) the test frequency shall be set to Weekly. By default the system will be set to Weekly if UL985 is selected on Alarm.com
Communication Test Start Time	Randomized	Select the time of day that the panel will send its Communication Test. If no time is selected the time will automatically be randomized.

INSTALLER/DEALER SETTINGS

Setting	Default	Description
<p>SIA Limits</p> <p>NOTE: For UL resi burg set entry delay to 45 sec and exit delay to max 120 sec. For UL Commercial Burg (UL2610) maximum entry and exit delay should not exceed 60 sec.</p> <p>NOTE: For ULC Security Level I (resi burg) set entry delay to 180 sec. For ULC Security Level II (commercial burg) set entry delay to 60 sec and exit delay to 45 sec max.</p> <p>NOTE: For EN Grade 2 installations set Entry Delay to 45 sec and Exit Delay to 30 sec.</p>	<p>Enabled</p>	<p>When enabled, the range for entry and exit delays is as follows: -Entry delay: 30-240 seconds, Exit Delay: 45-254 seconds</p> <p>When disabled, the range for entry and exit delays are as follows: -Entry delay: 5 to 240 seconds, Exit delay: 5 to 254 seconds</p> <p>When enabled the range for Dialer Delay is: 15 to 45 seconds When disabled the range for Dialer Delay is: 0 to 254 seconds</p>
<p>EN Grade 2</p>	<p>Disabled</p>	<p>The setting enables EN Grade 2 compliance on the Panel. When Enabled, the following behaviors and/or settings are changed automatically:</p> <ul style="list-style-type: none"> - Entry Procedure (EU) - follows entry procedures and alarm transmission delays specified by EN 50131 - Disables the "Auto Bypass" setting so that the Panel will protest arming when sensor and panel trouble conditions are present (i.e. Open, Tamper, Low Battery, etc) - Trouble condition alerts cannot be acknowledged until the condition is resolved - Trouble beeps are expanded to include fault indications required by EN 50131 - "Screen Lock" setting is enabled automatically. Screen will lock 30 seconds after Disarming - A new icon called "EU Events" is added to the "Settings" page which records mandatory history events specified by EN 50131. - "Loss of Supervisory Signals for PowerG Non-Emergency Sensors" is set to 2 hours by default. - "LED Indicator" setting is Disabled automatically. - "Dealer or Installer Access Requires User Permission" setting is Enabled automatically.

INSTALLER/DEALER SETTINGS

Setting	Default	Description
EU Event Swinger Shutdown Count	3	Determines the number of times a particular event will record to "EU Events" log before shutdown. The count (3-10) will reset after and arm or disarm event. NOTE: This setting is greyed out and not selectable unless EN Grade 2 is Enabled.
Favorite Languages	English/Español	Set the Panel's language toggle to your favorite 2 languages. Choose from English (United States), Français (Canada), Español (Estados Unidos), Italiano (Italia), Nederlands (Nederland), Norsk bokmål (Norge), Svenska (Sverige), Íslenska (Ísland), Deutsch (Deutschland), Magyar, (Magyarország), Dansk (Danmark), Română (România), Portuguesa (Portugal), Polskie (Polska), Suomalainen (Suomi), Français (France), Español (España), Hebrew, Türk (Türkiye).
LED Indicator	Enabled	Manually Enable/Disable the LED Status Light on the panel. NOTE: This setting will automatically be set to Disabled when EN Grade 2 is Enabled.
6 Digit User Code	Disabled	This is a global setting for all codes used on the panel and changes the input from 4 digits to 6 digits. When enabled, a "00" will be appended to all existing 4 digit codes
Commercial Sensor and Device Names	Disabled	Enabling this features changes the sensor name vocabulary from residential naming to commercial naming.
Wellness Support	Disabled	When Enabled, Auxiliary Pendants learned into Group 6 behave like a traditional PERS pendant. The system generates a signal to Alarm.com but does not generate a loud local alarm that needs to be disarmed between button presses. NOTE: This feature cannot be enabled if Partitions are enabled.

INSTALLER/DEALER SETTINGS

Setting	Default	Description
WI-FI Warning Messages	Enabled	When enabled the panel display will automatically revert to the Manage My System page as the default page if Wi-Fi is not connected to encourage end users to stay connected.
Partitions	Disabled	Create up to 4 partitions by enabling this feature.
Other Automation	Disabled	When Enabled, the Panel can support Zigbee Automation devices as well as Deako Lighting integrations. These devices are added through the "Other Automation" icon that will appear under the "Devices" icon. NOTE: Zigbee integration requires that a Zigbee daughter card be installed in the panel. Not evaluated for UKCA or CE/EN Grade 2.
Zwave Frequency Region	Varies by Region	Sets automatically based on install region and Z-Wave hardware installed in the panel or manually choose between United States, European Union, Australia/New Zealand, Hong Kong, Malaysia, India, Israel, Russia, China, Japan or Korea.
PowerG Camera Image Capture Count	1	Determines the number of Images to be uploaded by any PowerG PIR CAM when triggered during an Alarm. Choose between 1 or 10.
PowerG Camera Alarm Image Upload Limit	Enabled	Determines if PowerG PIR CAMs upload only images from the first motion event during an arming period (Enabled) or if they will upload images from all motion events for that arming period (Disabled).
Power Down Event Communication	Disabled	Determines if the Panel sends a unique event code (enabled) or not (disabled) to ADC and the CS if the Master Code is used to access the Power Down icon under Advanced Settings.

INSTALLER/DEALER SETTINGS

Setting	Default	Description
Security Page	Enabled	Choose whether or not you want the “Security Page” to appear as part of primary user interface on the panel. NOTE: This feature can not be disabled if Partitions are enabled.
Wellness Page	Disabled	Choose whether or not you want the “Wellness Page” to appear as part of primary user interface on the panel. NOTE: This feature can not be enabled if Partitions are enabled.
Check-in/Check-Out	Disabled	Choose whether or not you want a “Check-in” and “Check-out” button to appear as part of the Wellness Page UI. This feature allows a nurse to check in/out and have their picture taken by the panel as record of their visit. NOTE: The Wellness Page must be enabled in order for this feature to also be enabled.
Home Control Page	Disabled	Choose whether or not you want the “Home Control Page” to appear as part of primary user interface on the panel. NOTE: Before the Home Control Page can be enabled there must be at least two (2) different “types” of automation devices added to the panel (Lights, Locks or Thermostats). This feature can not be enabled if Partitions are enabled.
Door Lock Page	Enabled	Choose whether or not you want the “Door Lock Page” to appear as part of primary user interface on the panel anytime a Door Lock is added as a device.
Thermostat Page	Enabled	Choose whether or not you want the “Thermostat Page” to appear as part of primary user interface on the panel anytime a Thermostat is added as a device.
Scenes Support	Enabled	When enabled, a new icon will appear in the panel UI on left hand footer enabling the use of Scenes that have been created on Alarm.com. NOTE: This feature cannot be enabled if Partitions are enabled.

INSTALLER/DEALER SETTINGS

Setting	Default	Description
Stream Live Video Cameras to IQ Remote	Disabled	This setting allows a user to view cameras from the IQ Remote. When enabled, Cameras that are streaming to the primary panel will also stream to the IQ Remote.
IQ WiFi Dashboard	Enabled	Determines whether or not the IQ WiFi Dashboard is shown as part of the primary user interface pages when connected to an IQ WiFi or IQ WiFi 6.
IQ WiFi Profile Security	Disabled	Determines whether to show devices paired to the Security Network of an IQ WiFi or IQ WiFi 6 (Enabled) in the WiFi profiles section or not (Disabled).
Unpair IQ WiFi	Unpair the Panel from an IQ WiFi or IQ WiFi 6 network and delete all the IQ WiFi data from the Panel.	
PowerG RF Jam Detection	Disabled	When enabled the system can detect when an unusual amount of RF signals are being transmitted in the PowerG spectrum leading to a potential loss of connectivity. This event reports to the central station when enabled. Choose from Disabled, UL20/20 or En 30/60. NOTE: For EN Grade 2 certified installations the option shall be enabled and set to EN 30/60.
Jam Detection	Disabled	When enabled the system can detect when an unusual amount of RF signals are being transmitted on the frequency of the legacy daughter card installed in the panel (319.5MHz, 345MHz or 433MHz) leading to a potential loss of connectivity. This event reports to the central station when enabled. NOTE: Not evaluated for UK for CE/EN Grade 2
Jam Detection Local Alarm NOTE: Not evaluated by UL/cUL, UKCA or EN Grade 2	Disabled	When enabled the system will sound a local alarm. "Jam Detection" must be active for this to function properly.

INSTALLER/DEALER SETTINGS

Setting	Default	Description
SRF Jam Sensitivity Level NOTE: Not evaluated for UK or CE/EN Grade 2	Normal	Choose between HIGH and NORMAL sensitivity levels.
Zigbee Jam Detection	Disabled	Future use.
Zigbee Jam Sensitivity Level	Disabled	Future use.
Allow Master Code to Access Security Sensors	Disabled	Allow the Master Code to access to the Security Sensor icon, including Auto Learn Sensor, Add Sensor, Edit Sensor, Delete Sensor, Sensor Status & Sensor Group.
Open/Close Reports Allowed For Auto Learn	Enabled	Rather than sending a tamper to auto learn a sensor, enabling this will allow an open/close of the sensor to trigger auto learn.
Panel Glass Break Detector NOTE: Not evaluated for UK or CE/EN Grade 2	Disabled	Creates an independent zone that leverages the panel's built-in microphones to act as a glass break detector. This will fall into the zone order at the time you enable this feature. NOTE: This feature cannot be Enabled if Panel Ambient Noise Detection is Enabled.
Panel Motion Detector NOTE: Not evaluated for UK or CE/EN Grade 2	Disabled	Creates an independent zone that leverages the panel's built-in camera to act as an activity motion detector. This will fall into the zone order at the time you enable this feature. Motion can trip once every 4 minutes. NOTE: The panel motion detector is for activity monitoring and automation only (Group 25) and will not create an alarm condition or act as a security PIR.

INSTALLER/DEALER SETTINGS

Setting	Default	Description
Panel Ambient Noise Detector	Disabled	When Enabled, the Panel's built-in microphones can monitor for loud noise detection above a settable dB threshold and generate an alert. Useful for MDU, apartments and short term rentals where noise complaints are a concern. After an alert is generated, a 30 second cool down period is instituted. NOTE: This feature cannot be Enabled if Panel Glass Break Detector is Enabled.
Ambient Noise Threshold	85 dB	Set the threshold at which the Panel Ambient Noise Detector determines there is enough noise to generate an alert. Choose from values between 75 and 95 dB. NOTE: This setting is greyed out and not selectable unless Panel Ambient Noise Detector is Enabled.
Noise Detector Duration	20 min	Determines the length of time for which the panel must detect noise above the threshold level in order to generate a noise notification.
Noise Detector Popup	Disabled	Determines whether the panel indicates locally on the screen that noise event has been detected.
Zigbee Network Type NOTE: Not evaluated for UK or CE/EN Grade 2	Home Automation and Security	Choose which type of Zigbee network you'd like to use. Options are Home Automation and Security or Smart Energy. NOTE: This setting only appears when a Zigbee daughter card is installed in the Panel. When paired to UL Listed Zigbee devices, Zigbee can be used for UL/ULC Listed Residential Fire and Burglary applications.
Light Reporting (PowerG)	Disabled	When Enabled, PowerG devices that support light sensor capabilities report light status to the Panel. Data is stored for future use.
Temperature Reporting (PowerG)	Disabled	When Enabled, PowerG devices that support temperature measurement, report temperature information to the Panel. Data is stored for future use.

INSTALLER/DEALER SETTINGS

Setting	Default	Description
System Health Check	Enabled	Determines whether the System Health Check feature shows up on the Manage My System primary user interface (enabled) or not (disabled).
System Health Check as Default Home Screen	Disabled	Panel home screen defaults to the System Health Check page if troubles exist.
Delete All Sensors	Deletes all security sensors and Bluetooth devices programmed in the panel.	
Delete All Z-Wave Devices	Performs a factory reset on the Z-Wave controller. Does not factory reset previously included devices.	
Zigbee Reset	Deletes all Zigbee sensors and resets the Zigbee Network.	
Master Reset*	Restores panel to factory settings and erases all content.	
Data Recycle	This feature erases all User data previously stored. (Wi-Fi SSID & Password, User Codes, Panel Camera Images, Custom Photo Frame Images, Message Center & Panel Event History).	
IQ Remote Reset Authentication	Disabled	If Enabled, the IQ Remote will require authentication (Dealer or Installer Code) to master reset it.

SYSTEM LOGS





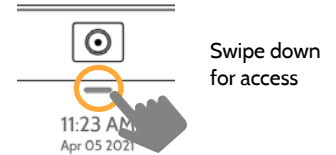

System logs allow the panel to send non-customer identifying information to the server for troubleshooting and bug identification.

Setting	Default	Description
Upload logs to the server	<i>Requires manual push</i>	Tell the panel to begin uploading a history of its activity to the server. This information is used to troubleshoot bugs and diagnose panel problems. The panel will upload any logs saved in its memory
Auto Upload Logs	Disabled	Automatically upload the system's log to the servers every 24 hours
Log Level	Debug	<p>Tell the panel how much information to record in log files.</p> <p>No log output: No information recorded Fatal: Record fatal or severely problematic information only Error: Record all errors and fatal issues Warn: Record warnings, errors, and fatal issues Info: Record all generic, non-customer related information Debug: Record diagnostic messages, Info, Warnings, Errors, and Fatal issues Verbose: Record all non-customer identifying information</p>

FIND IT



-  SETTINGS
-  ADVANCED SETTINGS
-  ENTER CODE (1111, 2222)
-  INSTALLATION
-  SYSTEM LOGS

SIREN AND ALARMS



Siren and Alarms

Change siren and alarm settings for certain types of alarm events.

Setting	Default	Description
Panel Sirens	All Sirens On	<p>All Sirens Off: This will disable the siren for all alarm types, except for life safety devices, including any hardwire or wireless external sirens.</p> <p>All Sirens On: This is the default setting which enables the siren for all alarms</p> <p>Installer/Test Mode: This disables the siren for all alarm types including any paired or hardwired external sirens for 30 mins then all sirens are re-enabled</p>
Siren Annunciation	Disabled	<p>Panel siren pauses periodically to announce which locations have triggered the alarm.</p> <p>NOTE: for UL/cUL this feature is not allowed for Fire, CO, Burglar Alarm</p>
Fire Verification	Disabled	<p>When enabled, panel requires two fire events from smoke detector (one detector twice or two detectors once each)</p> <p>NOTE: Not allowed on UL/cUL installations</p>

FIND IT

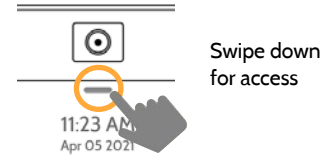

Swipe down for access



SETTINGS



ADVANCED SETTINGS



ENTER CODE (1111, 2222)



INSTALLATION



SIREN AND ALARMS

SIREN AND ALARMS

Setting	Default	Description
Burglary Alarm Confirmation	Disabled	When enabled, a confirmed alarm requires two sequential burglary alarms within the Burglary Alarm Confirmation Timer window. NOTE: This setting is greyed out and unavailable unless EN Grade 2 is enabled.
Burglary Alarm Confirmation Timer	30	Timer used for Burglary Alarm Confirmation. NOTE: This setting is greyed out and unavailable unless EN Grade 2 is enabled.
Severe Weather Siren Warning	Enabled	When enabled, siren will sound when the panel receives a severe weather alert. When disabled, panel will use severe weather chime
Dialer Delay NOTE: Shall not be used on EN Grade 2	:30	Amount of time (in seconds) before panel will attempt call to central station after an alarm event is triggered When SIA Limits enabled: :15 to :45 seconds When SIA Limits disabled: :0 to :254 seconds
Siren Timeout	4 min	Determine how long before siren stops sounding during an alarm event (4 minutes to 15 minutes). NOTE: For UL/cUL residential fire/burg applications the minimum bell timeout shall be set to 5 min. For UL Commercial Burglary installations, minimum bell time out shall be set to 15 minutes. For EN Grade 2 the minimum bell timeout shall be 90 sec and maximum bell timeout shall not exceed local regulations.
Water/Freeze Siren/Temperature	Enabled	When enabled, siren will sound when a water or freeze detector is triggered. When disabled, the panel emits a “water” tone

SIREN AND ALARMS

Setting	Default	Description
Police Panic	Enabled	Allows Police Panic to be enabled or disabled.
Fire Panic	Enabled	Allows Fire Panic to be enabled or disabled.
Auxiliary Panic	Enabled	Allows Auxiliary Panic to be enabled or disabled.
Audible Siren for Wireless Supervisory Failures	Disabled	When this setting is enabled and the system is armed, supervisory failures for non-emergency sensors are treated the same as a tamper and cause an alarm to be generated.
PowerG Smoke Detector Siren	Fire Alarms Only	When set to "Fire Alarms Only", PowerG Smoke Detectors that are learned into the system will only sound during fire alarm events. When set to "All Alarms", PowerG Smoke Detectors will act as additional wireless sirens and will sound during all alarm events.
Allow Master Code To Access Siren and Alarms	Disabled	Allow the master code to access these features and settings. NOTE: not allowed for UL/cUL.

SECURITY AND ARMING



Security and Arming

Change arming settings, entry and exit delays, enable Duress Authentication and more.

Setting	Default	Description
Dealer Code*	2222	Code to access all options
Installer Code	1111	Code to access installer options only
Swinger Shutdown	Enabled	Determines whether the panel allows the same sensor to trip the alarm more than once during the same arming period. When Enabled, the sensor will trip according to the Swinger Shutdown Count setting. When Disabled, a sensor may trip up to 128 times per arming period.
Swinger Shutdown Count	1	Determines the number of times the same sensor is allowed to trip the alarm during the same arming period (1-6). Swinger Shutdown must be enabled in order for this setting to work. NOTE: For EN Grade 2 it shall be set to 3
Panel Tamper	Enabled	This setting enables or disables the Panel Tamper switch on the back of the panel. NOTE: for UL/cUL and EN Grade 2 this setting shall be Enabled

FIND IT

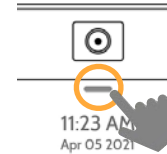

Swipe down for access



SETTINGS



ADVANCED SETTINGS



ENTER CODE (1111, 2222)



INSTALLATION



SECURITY AND ARMING

* Additional options available only through the Dealer Code.

SECURITY AND ARMING

Setting	Default	Description
Screen Lock	Disabled	When enabled, a screen lock page will appear. Screen lock restricts access to the panel based on valid user codes. NOTE: This setting is automatically enabled when Partitions are enabled, though it can subsequently be disabled if desired. It is also enabled for "EN Grade 2"
Secure Arming	Disabled	Require user code for arming the panel. NOTE: this option shall be enabled for UL/cUL and EN Grade 2
Refuse Arming When Battery Low	Disabled	Will not allow panel to arm if battery is low (below 8%). NOTE: This option shall be enabled for EN Grade 2
Auto Bypass	Enabled	Toggle whether or not to bypass open or tampered sensors automatically. NOTE: Shall be disabled for UL/cUL. This setting is turned off and greyed out when the "En Grade 2" setting is enabled.
Final Exit Door Arming	Disabled	When enabled, if Arm Away is selected at the panel then there is no timed exit delay. Instead, the system is not fully armed until an Entry/Exit door is violated. NOTE: This setting is greyed out an unavailable unless EN Grade 2 is enabled.
Auto Stay	Enabled	If panel is armed "Away" but a delay door is not opened, the panel assumes you are still home and changes arming to "Stay" mode
Arm Stay - No Delay	Enabled	Arm stay immediately with no countdown timer
Auto Exit Time Extension	Enabled	Automatically extend countdown timer if delay door is opened during countdown process a second time

SECURITY AND ARMING

Setting	Default	Description
Keyfob Instant Arming	Enabled	When enabled, turns off exit delay if keyfob is used to arm the system
Keyfob Alarm Disarm	Disabled	When enabled this will Allow a keyfob to disarm alarm events.
Keyfob Disarming	Enabled	When Disabled, a Keyfob will not be able to disarm the panel
Engineer's Reset	Disabled	If a confirmed alarm occurs on a burglary zone, the system is locked out after disarming until a 5 digit reset code provided by the installer is entered in.
Allow Master Code to Access Security and Arming	Disabled	Allow the master code to access these features and settings. NOTE: this option shall be disabled for UL/cUL. This option shall be enabled for UL Commercial Burg installations.
Normal Entry Delay	30 Secs	How much time users have to enter their code after opening a door (30-240secs). With SIA limits disabled the minimum time can be set to 5 secs. NOTE: For UL Commercial Burg (UL2610) maximum entry delay should not exceed 60s. For EN Grade 2 it shall not exceed 30 sec.
Normal Exit Delay	60 Secs	How much time users have to exit the location before the panel arms itself (30-254secs). With SIA limits disabled the minimum time can be set to 5 secs. Door/Window group 10 follows the "Normal Exit Delay" NOTE: For UL Commercial Burg (UL2610) maximum exit delay should not exceed 60s. For EN Grade 2 the maximum exit delay should not exceed 30s.

SECURITY AND ARMING

Setting	Default	Description
Long Entry Delay	100 Secs	A second separate entry delay that can be used on a sensor needing more time when tripped (45-240secs). With SIA limits disabled the minimum time can be set to 5 secs. NOTE: Not for use with EN Grade 2
Long Exit Delay	120 Secs	A second separate exit delay that can be used on a sensor needing more time when tripped (45-254secs). With SIA limits disabled the minimum time can be set to 5 secs. Door/Window group 12 follows the "Long Exit Delay". NOTE: Not for use with EN Grade 2

CAMERA SETTINGS



Camera Settings

Enable/Disable Disarm photos and Alarm photos. Secure images requiring a code to either view or delete.

Setting	Default	Description
Secure Delete Images	Enabled	When enabled, a code is required to delete disarm and alarm photos
Panel Camera	Enabled	When disabled, all Panel Camera related functions are turned off, including: Disarm Photos, Alarm Photos, Alarm Videos and Settings Photos. Additionally the Panel Camera Page is also removed
Disarm Photos	Enabled	When enabled, the built-in camera will take a single photograph when a user disarms the panel. When disabled, the panel will not capture images upon disarm
Alarm Photos	Enabled	When enabled, the built-in camera will take a single photograph during an alarm event
Alarm Videos	Enabled	When an alarm is triggered the panel will record a video clip for 4 mins from it's built in 8mp panel camera

FIND IT

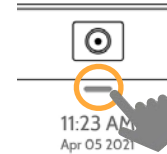

Swipe down for access



SETTINGS



ADVANCED SETTINGS



ENTER CODE (1111, 2222)



INSTALLATION



CAMERA SETTINGS

Note: Supplementary feature not evaluated by UL/cUL or EN Grade 2

CAMERA SETTINGS

Setting	Default	Description
Settings Photos	Disabled	Whenever Advanced Settings are accessed the panel will take and store a photo
Allow Master Code to Access Image Settings	Disabled	Allow the master code to access these features and settings

Z-WAVE DEVICE LIST*

Note: This feature has not been evaluated for EN Grade 2

FIND IT



Z-Wave Device List

Shows device specific information for programmed Z-Wave devices.

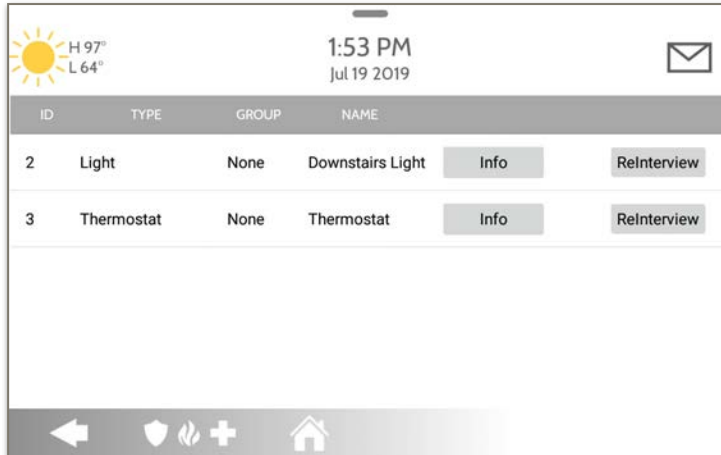

Pressing “Info” displays:

- Product Info
- Protocol Info
- Application Info
- Supported Command Classes

Pressing “Re-Interview” will resend all initial pairing commands to that device.

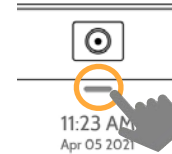

Swipe down for access



SETTINGS



ADVANCED SETTINGS



ENTER CODE (1111, 2222)



Z-WAVE DEVICE LIST

*This page only available through the Dealer Code.

SOUND



Sound

Customize panel sounds. Enable/Disable voices, chimes, trouble beeps and more.

Setting	Default	Description
Volume	n/a	Controls the panel's voice volume, beeps and chime volume, media volume (help videos) and door bell volume through individual sliders
Edit Chimes	n/a	Allows you to select from various chimes for each individual device
Voice Settings		
Voices	Enabled	This is a global setting for Sensors, Panel messages, Activity Monitoring Sensors, and Z-Wave device voices and indicates whether the panel should "speak"
Sensors	Enabled	Turns Sensor voices on (enabled) or off (disabled)
Panel	Enabled	Turns Panel voices on (enabled) or off (disabled)
Activity Monitoring	Enabled	Turns Activity Monitoring voices on (enabled) or off (disabled)

FIND IT

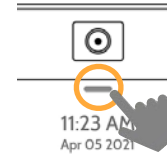

Swipe down
for access



SETTINGS



ADVANCED SETTINGS



ENTER CODE (1111, 2222)



SOUND

SOUND

FIND IT

Setting	Default	Description
Z-Wave Device Voice Prompts	Enabled	Turns Z-Wave Device voices on (enabled) or off (disabled)
Z-Wave Remote Voice Prompts	Enabled	Turns voices on (enabled) or off (disabled) for Z-Wave devices being controlled remotely (via Alarm.com)
Chime Settings		
All Chimes	Enabled	This is a global setting for Sensors, Panel messages and Activity Monitoring Sensors chimes and indicates whether the panel should emit tones or “beeps”
Sensor Chimes	Enabled	Turns chimes on (enabled) or off (disabled) for Sensors
Panel	Enabled	Turns Panel chimes on (enabled) or off (disabled)
Activity Sensor	Enabled	Turns Activity Sensor chimes on (enabled) or off (disabled)

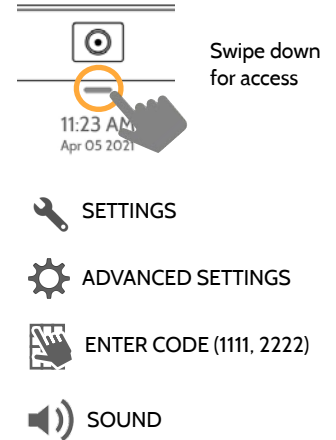

SOUND

FIND IT

Setting	Default	Description
Trouble Beeps		
Trouble Beeps**	Disabled	Toggles all sensor and panel trouble beeps on or off. By default all trouble beeps are disabled
PowerG Siren Trouble Beeps	Disabled	Determines whether PowerG sirens sound trouble beeps (enabled) or not (disabled)
Sensor Low Battery**	Disabled	Panel sounds when a sensor battery is low. Chime type and frequency are set below. By default these sounds are disabled
Sensor Tamper Beeps**	Disabled	Panel sounds when a sensor is tampered. Chime type and frequency are set below. By default these sounds are disabled
Panel Tamper Beeps**	Disabled	Panel sounds when tampered or opened. Chime type and frequency are set below. By default these sounds are disabled
Edit Trouble Beep Chimes	n/a	Select the chime type for Sensor Low Battery, Sensor Tamper, and Panel Tamper
Trouble Beeps Timeout***	30	Determines the amount of time between each trouble beep. Length can be set between 3-60 mins. (default is 30 mins)
Fire and Life Safety Device Trouble Beeps	Enabled	Panel will sound a trouble alert if a fire safety device is tampered, failed or has a low battery (enabled by default)

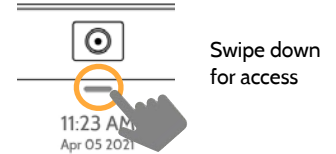

**Set to Enabled for EN Grade 2 installations.

*** Setting shall be set to 3 min for EN Grade 2 installations

SOUND

FIND IT

Setting	Default	Description
Partition Sounds*		
Global Fire Siren	Enabled	When Partitions are enabled this setting determines whether Fire alarms sound in all partitions (enabled) or in only the partition they are assigned to (disabled)
Global Intrusion Sounds and Sirens	Disabled	Intrusion alarms and entry/exit sounds will sound in all partitions
Global Auxiliary Sirens	Disabled	Auxiliary alarm will sound in all partitions
Global Chimes and Voices	Disabled	Chimes and voices will play in all partitions
All Sounds in Partition 1	Disabled	Sounds and alarms from all other partitions will sound in partition 1
Other Sounds		
Touch Sounds	Enabled	This setting determines whether a touch sound is played when touching the screen (enabled) or not (disabled)
Exit Beeps	Enabled	Play exit beeps for the Quick Exit and Quick Access feature on the panel (enabled) or not (disabled)

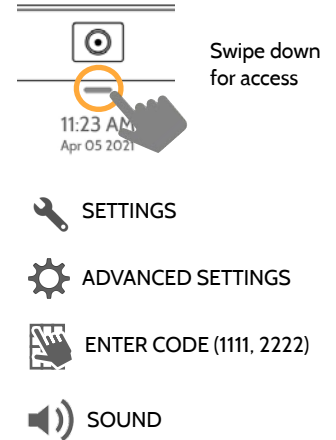

* Additional settings available only when Partitions are enabled.

PARTITIONS*

Note: This feature has not been evaluated for EN Grade 2

FIND IT



Partitions

Edit the default name of a partition and view a list of users and sensors that are currently assigned to a given partition. Partitions 1, 2, 3 & 4 only appear when Partitions are enabled and when at least one sensor is learned into them.



Overview:

View the number of partitions set up on a system. There must be at least one sensor assigned to a partition before it can be viewed/edited



Info:

View Users and Sensors associated with each partition



Edit:

Rename a partition that suits its location or area being protected

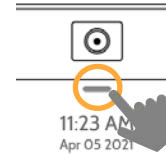

Swipe down for access



SETTINGS



ADVANCED SETTINGS



ENTER CODE (1111, 2222)



PARTITIONS

* The "Partitions" icon will only appear if Partitions are enabled under Installer/Dealer Settings

LOCAL AUTOMATION*



Local Automation

This hardcoded scene is designed for Panels installed in new construction properties that do not yet have an Alarm.com account activated, but that need to manage Z-Wave devices locally in a “vacant home mode”.

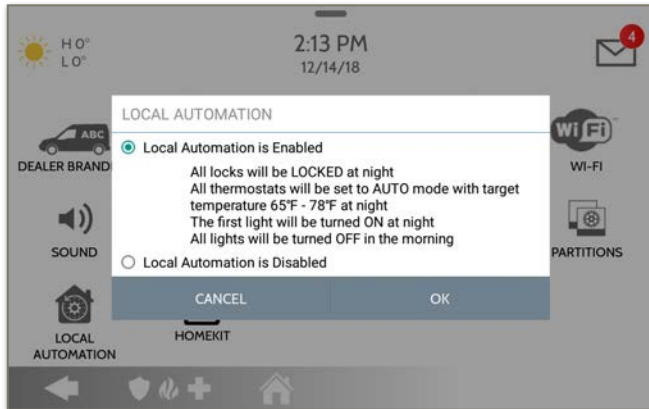

Runs Daily:

- Automatically LOCK all locks at night (8pm)
- Set all thermostats to AUTO mode with a target temperature of 65°F - 78°F (18.3°C - 25°C)
- Turn Light 1 ON at night (8pm) and then turn all lights OFF in the morning (6am)

FIND IT

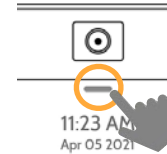

Swipe down for access



SETTINGS



ADVANCED SETTINGS



ENTER CODE (1111, 2222)



LOCAL AUTOMATION

*This page only available through the Dealer Code.

DEVICES

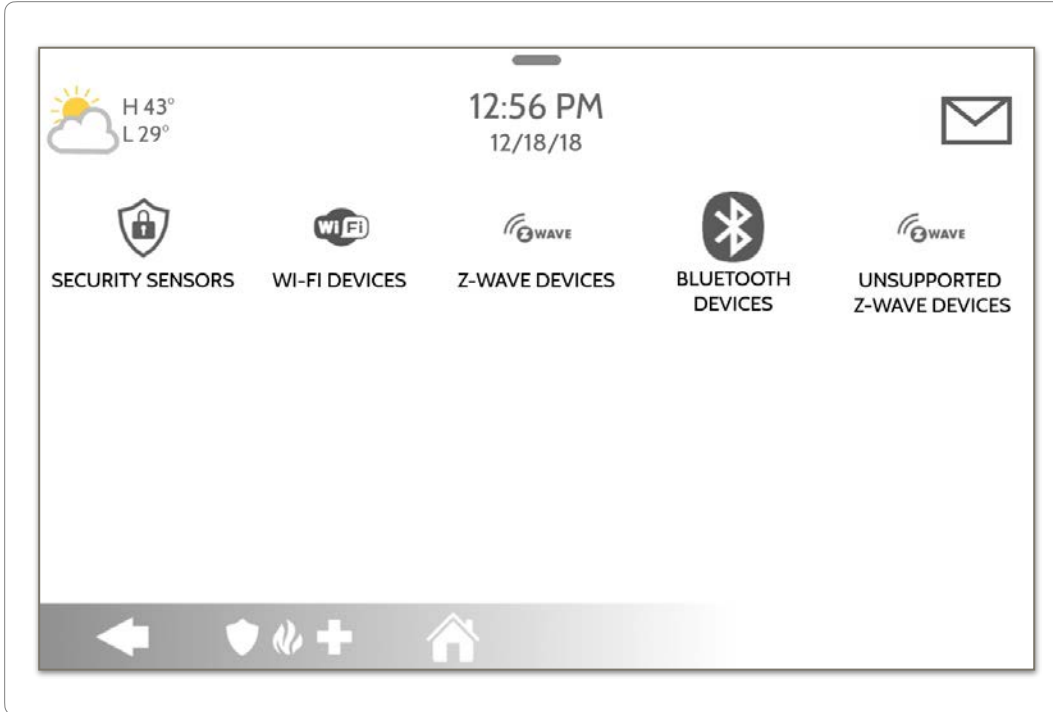

FIND IT

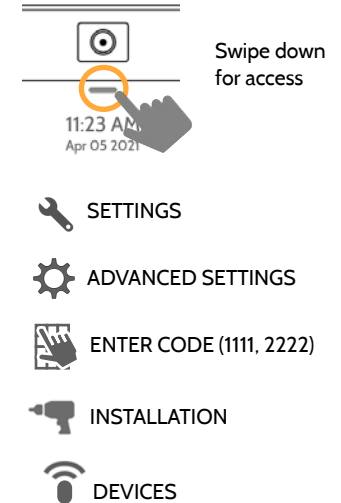

*Unsupported Z-Wave Devices icon only available through the Dealer Code.

SECURITY SENSORS

SECURITY SENSORS



Security Sensors

Add, edit or delete up to 128 security RF or life safety devices.



Auto Learn Sensor

Pair sensors quickly by tripping or tampering and then editing the information



Add Sensor

Pair sensors manually by typing in a DL code or Serial number



Edit Sensor

Make changes to existing sensors



Delete Sensor

Remove a sensor



Sensor Status

Monitor sensor status in realtime



Sensor Group

Quick reference to all sensor groups and their actions



Panel Motion Settings

Adjust Panel Motion sensitivity and masking areas



Remove All PowerG Sensors

Delete all PowerG sensors from the Panel



Remove All Zigbee Sensors

Delete all Zigbee sensors from the Panel



PowerG Output Rules

Configure PGMs when using the PGxWLSHW8 or PGxHRDW8

FIND IT

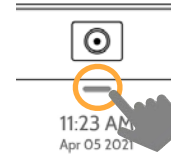

Swipe down for access



SETTINGS



ADVANCED SETTINGS



ENTER CODE (1111, 2222)



INSTALLATION



DEVICES



SECURITY SENSORS

AUTO LEARN SENSOR

Note: SRF433 is not for EN Grade 2 Installations. SRF319 and SRF345 are not for UKCA or CE/EN Grade 2 Installations

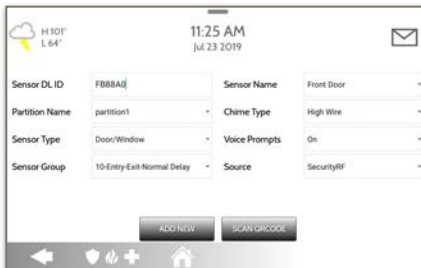

1. Select “Auto Learn Sensor”

2. Open/Close or Tamper a sensor to enroll. For PowerG contacts, hold the “enroll” button until the yellow LED flashes.

3. Panel will chime and display the sensor’s DL code. Select OK to confirm.

4. Configure **Partition Name**, **Sensor Type**, **Sensor Group**, **Sensor Name**, **Chime Type** and **Voice Prompts** with the smart filtering drop down lists.

5. Select “Add New” to complete and move to the next sensor.

NOTE:

When enrolling an “S-Line” sensor, the panel will auto detect that it’s encrypted and change the “Source” field to S-Line.

IQ Panel 4 only: When enrolling a sensor of a different frequency (345MHz, 433MHz, PowerG) the Source field will change to accommodate the incoming signal type.

When a sensor with the frequency 345 is used, you will be given an additional field to specify the Loop #.

ADD SENSOR



Sensor DL ID	<input type="text" value="Enter Sensor DL ID"/>
Partition Name	<input type="text" value="partition1"/>
Sensor Type	<input type="text" value="Door/Window"/>
Sensor Group	<input type="text" value="10-Entry-Exit-Normal Delay"/>
Sensor Name	<input type="text" value="Front Door"/>
Chime Type	<input type="text" value="High Wire"/>
Voice Prompts	<input type="text" value="On"/>
Source	<input type="text" value="SecurityRF-319"/>

ADD NEW

SCAN QR CODE

1. Select “**Add Sensor**” (NOTE: These same fields can be edited later from the “Edit Sensor” app)
2. Select the appropriate **Source** based on the frequency of device being manually learned in
3. Tap the field marked “**Sensor DL ID**” to open the keyboard. Enter the DL code or Sensor ID on the back of the device and touch “Done”
4. Use the drop down menu to select which **Partition** you would like the sensor to be added to (if enabled)
5. Choose **Sensor Type** from list
6. Indicate **Sensor Group** from list
7. Choose **Sensor Name** from the list or create a “Custom Name” using the built in keyboard with Custom Text to Speech.
8. Choose **Chime Type** from list
9. Indicate whether you want **Voice Prompts** on or off
10. Click “**Add New**” to save the information and complete the process.

SCAN QR CODE

*This feature is only used with Qolsys S-Line 319 Sensors that have compatible QR code labels on the box



Sensor DL ID	<input type="text" value="Enter Sensor DL ID"/>
Partition Name	<input type="text" value="partition1"/>
Sensor Type	<input type="text" value="Door/Window"/>
Sensor Group	<input type="text" value="10-Entry-Exit-Normal Delay"/>
Sensor Name	<input type="text" value="Front Door"/>
Chime Type	<input type="text" value="High Wire"/>
Voice Prompts	<input type="text" value="On"/>
Source	<input type="text" value="SecurityRF-319"/>

ADD NEW

SCAN QR CODE

1. Select “**Add Sensor**”

2. Tap the button marked “**Scan QR Code**” to open the camera. Hold the QR code label on the sensor box up to the camera to automatically scan the Sensor DL ID

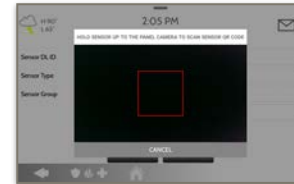

3. Use the drop down menu to select which **Partition** you would like the sensor to be added to (if enabled)

4. Choose **Sensor Type** from list

5. Indicate **Sensor Group** from list

6. Choose **Sensor Name** from the list or create a “Custom Name” using the built in keyboard with Custom Text to Speech.

7. Choose **Chime Type** from list

8. Indicate whether you want **Voice Prompts** on or off

9. Click “**Add New**” to save the information and complete the process.

PARTITION NAME

When Partitions are enabled (see Dealer/Installer Settings) you may then assign a sensor to a specific partition. This will allow independent control and arming of that partition without disrupting the main panel's master partition. You may create and use up to 4 partitions.

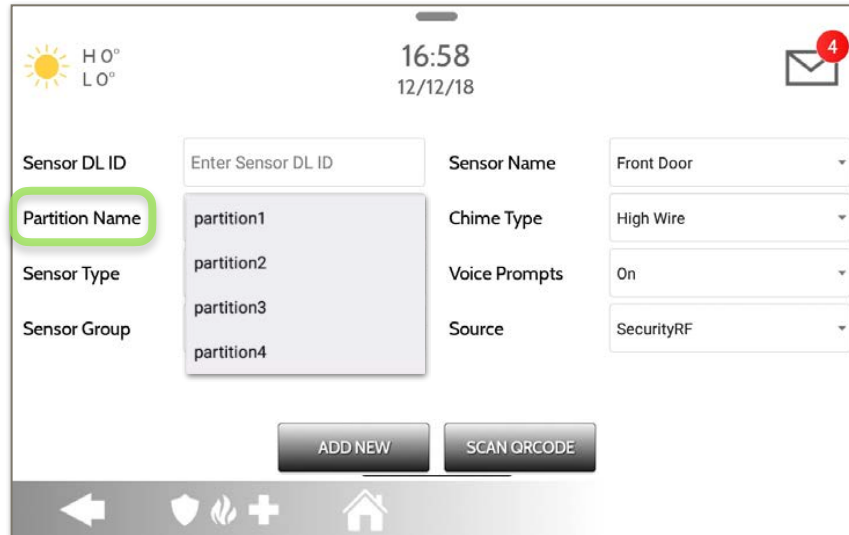

The screenshot displays a mobile application interface for configuring a security sensor. At the top, there is a weather icon, temperature range (H 0°, L 0°), the time (16:58), and the date (12/12/18). A notification icon with the number 4 is in the top right corner. The main form has the following fields:

- Sensor DL ID:** A text input field with the placeholder "Enter Sensor DL ID".
- Partition Name:** A dropdown menu with options "partition1", "partition2", "partition3", and "partition4". This field is highlighted with a green circle.
- Sensor Type:** A dropdown menu.
- Sensor Group:** A dropdown menu.
- Sensor Name:** A dropdown menu with the selected value "Front Door".
- Chime Type:** A dropdown menu with the selected value "High Wire".
- Voice Prompts:** A dropdown menu with the selected value "On".
- Source:** A dropdown menu with the selected value "SecurityRF".

At the bottom of the form, there are two buttons: "ADD NEW" and "SCAN QR CODE". Below the form is a navigation bar with icons for back, shield, fire, plus, and home.

SENSOR TYPE

When adding or editing security devices you can choose from the following sensor types:

- Door/Window
- Motion
- Glass Break
- Key Fob
- Keypad
- Auxiliary Pendant
- Smoke Detector
- CO Detector
- Hardwire Translator
- Wireless Translator
- Temperature
- Heat
- Water
- Shock Sensor
- Freeze
- Tilt
- Door Bell
- Smoke-M
- Door/Window-M
- Occupancy Sensor
- Siren
- High Temperature

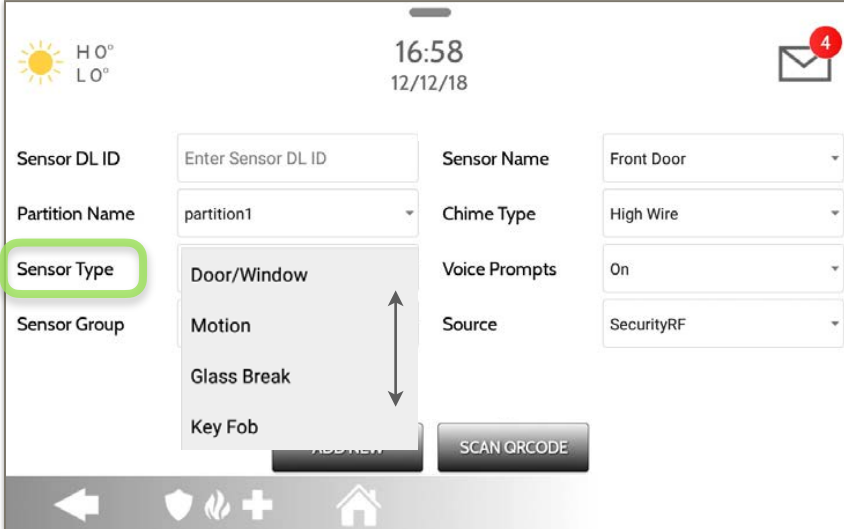

The screenshot shows a configuration screen for a security device. At the top, there is a weather icon, temperature (H 0°, L 0°), time (16:58), and date (12/12/18). A notification icon with the number 4 is in the top right. The main form has the following fields:

- Sensor DL ID:** Enter Sensor DL ID
- Partition Name:** partition1
- Sensor Type:** A dropdown menu is open, showing options: Door/Window (highlighted with a green circle), Motion, Glass Break, and Key Fob.
- Sensor Group:** Motion
- Sensor Name:** Front Door
- Chime Type:** High Wire
- Voice Prompts:** On
- Source:** SecurityRF

At the bottom, there are navigation icons (back, shield, fire, plus, home) and a 'SCAN QR CODE' button.

Note: for UL/cUL, only UL/cUL listed devices shall be used: Door/Window contact: 60-362N-10-319.5, Motion Detector: 60-639-95R, Smoke Detector: IQ Smoke QS5110-840. For UL2610 installations use only UL listed PowerG devices.

SENSOR GROUP

Sensor groups will change the behavior of the sensor. These are tied directly to your Sensor Type, displaying only what's relevant.

Touch the "Sensor Group" drop down to change.

A full list of Sensor Groups and descriptions can be found under "Sensor Groups" listed in the manual below.

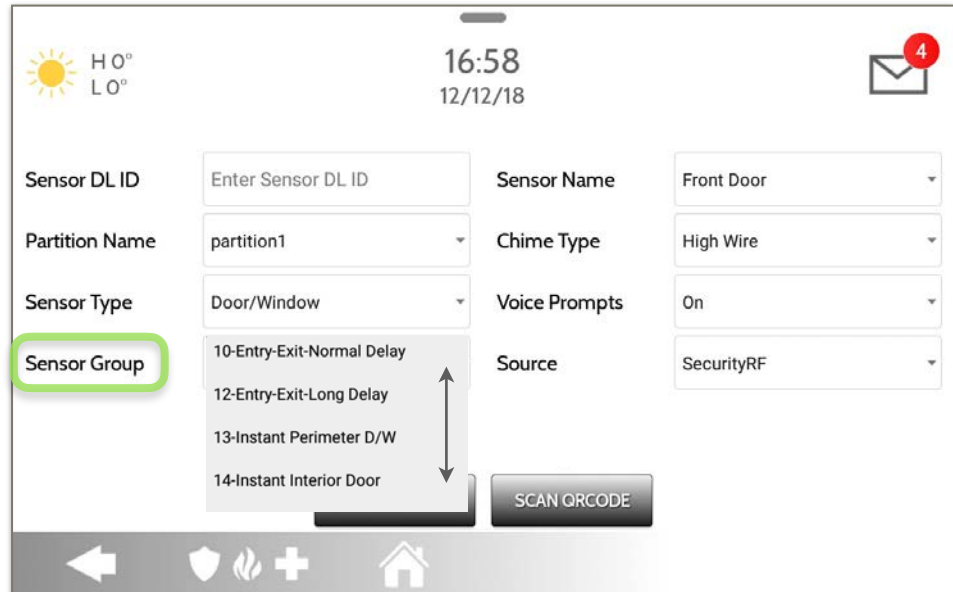

The screenshot shows a mobile application interface for configuring a sensor. At the top, there is a weather widget showing a sun icon, high/low temperatures (H 0°, LO°), the time (16:58), and the date (12/12/18). A notification icon with the number 4 is in the top right corner. The main configuration area includes several dropdown menus and text input fields:

- Sensor DL ID:** Enter Sensor DL ID
- Partition Name:** partition1
- Sensor Type:** Door/Window
- Sensor Group:** A dropdown menu with a green highlight around it, containing the following options:
 - 10-Entry-Exit-Normal Delay
 - 12-Entry-Exit-Long Delay
 - 13-Instant Perimeter D/W
 - 14-Instant Interior Door
- Sensor Name:** Front Door
- Chime Type:** High Wire
- Voice Prompts:** On
- Source:** SecurityRF

A "SCAN QR CODE" button is located at the bottom right of the configuration area. At the very bottom of the screen is a navigation bar with icons for back, shield, fire, plus, and home.

SENSOR GROUPS

IQ Panel 4 supports PowerG along with ONE “legacy” frequency (319.5 MHz, 345 MHz, or 433 MHz) depending on which RF daughter card is pre-installed. Sensor Group numbers and behaviors remain the same across all frequencies. When pairing a 345 MHz sensor with the Panel, an additional option for “Loop” number will be shown. IQ Panel 4 also supports the use of Zigbee daughter card in conjunction with compatible Zigbee devices for UL/ULC Residential Fire and Burglary applications. **Note:** SRF433 is not for EN Grade 2 Installations. SRF319 and SRF345 are not for UKCA or CE/EN Grade 2 Installations

DOOR/WINDOW

GROUP	NAME	SUPERVISED	SCENARIO
10	Entry-Exit- Normal Delay	Y	Gives a period of time to exit the home or to disarm the panel when returning before sounding the alarm
12	Entry-Exit- Long Delay	Y	Gives a period of time to exit the home or to disarm the panel when returning before sounding the alarm. This can be a separate delay from the “normal delay”
13	Instant Perimeter D/W	Y	Door or window that triggers an alarm instantly when system is armed
14	Instant Interior Door	Y	An interior sensor that triggers an alarm instantly while armed to both stay and away. Does not trip if an entry/exit sensor is tripped first

DOOR/WINDOW

GROUP	NAME	SUPERVISED	SCENARIO
16	Away Instant- Follower Delay	Y	Interior door that triggers alarm instantly when system is armed to away mode only
25	Local Safety Sensor	Y	This sensor does not report or trigger an alarm. This is a chime only sensor when "Activity Monitoring" is active, regardless of panel status. Used for medicine cabinets, chemical storage etc
8	Reporting Safety Sensor	Y	This sensor reports to the central station and triggers an alarm when "Activity Monitoring" is active, regardless of panel status
9	Delayed Reporting Safety Sensor	Y	This sensor reports to the central station and triggers an alarm when "Activity Monitoring" is active, regardless of panel status. This sensor has an entry delay

*345 MHz door/window sensors will have the option to change the "Loop" number to 1 or 2. This will allow the sensor to be programmed twice as 2 different zones.

* Power G Door/Window contact PGx945, PGx309, PGx312 adds an additional drop down menu to determine the contact type, Reed Switch or Wired.

MOTION

GROUP	NAME	SUPERVISED	SCENARIO
17	Away- Instant Motion	Y	Active only when armed to “Away”, and trips instantly when motion is detected. Does not trip if an entry/exit sensor is tripped first
15	Stay- Instant Motion	Y	Active in both “Stay” & “Away” modes, and trips instantly when motion is detected. Does not trip if an entry/exit sensor is tripped first
35	Stay- Delay Motion	Y	Active in both “Stay” & “Away” modes. Triggers an entry delay when motion is detected. Does not trip if an entry/exit sensor is tripped first
20	Away- Delay Motion	Y	Active when armed to “Away”. Triggers an entry delay when motion is detected. Does not trip if an entry/exit sensor is tripped first
25	Safety Motion	Y	This sensor does not report or trigger an alarm. This is a chime only sensor when “Activity Monitoring” is active, regardless of panel status. Used for medicine cabinets, storage, activity tracking, etc

MOTION

GROUP	NAME	SUPERVISED	SCENARIO
43	Away- Instant, Stay-Delay Motion	Y	Active in both “Stay” & “Away” modes. During Away mode, trips instantly when motion is detected. Does not trip if an entry/exit sensor is tripped first. During Stay mode, triggers an entry delay when motion is detected.
44	Away- Instant Interior Motion	Y	Active only when armed to “Away”, and trips instantly when motion is detected. Does not follow entry/exit delay rules and is always instant.
45	Away- Stay- Instant Interior Motion	Y	Active in both “Stay” & “Away” modes. Trips instantly when motion is detected. Does not follow entry/exit delay rules and is always instant.

*345 MHz motion sensors will have the option to change the “Loop” number to 1, 2 or 3. This will allow the sensor to be programmed twice as 2 different zones where supported by the device.

*Power G Motion Detectors with Prefix 120, 122, 130, 140 and 142 offer additional functions such as High Traffic Shutdown and Sensitivity Level. Motions with prefix 123, 126, 127, 128 and 129 offer High Traffic Shutdown only as an additional function.

GLASS BREAK

*345 MHz glass break sensors can be programmed as “Loop” 1 only

GROUP	NAME	SUPERVISED	SCENARIO
13	Glass Break	Y	Active in both “Stay” and “Away” mode
17	Glass Break -Away Only	Y	Active in “Away” mode only

KEY FOB

*345 MHz Keyfobs will follow the IQ Panel’s Keyfob programming and functionality

GROUP	NAME	SUPERVISED	SCENARIO
1	Mobile Intrusion	N	Worn or carried , the button(s) is/are programmed to trigger a police panic
3	Mobile Silent	N	Worn or carried , the button(s) is/are programmed to trigger a silent police panic
4	Fixed Auxiliary	Y	Installed in a fixed location such as night stand, the button(s) is/are programmed to trigger an Auxiliary panic . NOTE: Medical functionality has not been evaluated for UL/cUL, UKCA or CE/EN Grade 2.
5	Fixed Silent Auxiliary	Y	Installed in a fixed location such as night stand, the button(s) is/are programmed to trigger a silent Auxiliary panic . NOTE: Medical functionality has not been evaluated for UL/cUL, UKCA or CE/EN Grade 2.

KEY FOB

*345 MHz Keyfobs will follow the IQ Panel's Keyfob programming and functionality

GROUP	NAME	SUPERVISED	SCENARIO
6	Mobile Auxiliary	N	Worn as a wrist watch or pendant, the button(s) is/are programmed to trigger an Auxiliary panic . NOTE: Medical functionality has not been evaluated for UL/cUL, UKCA or CE/EN Grade 2.
7	Mobile Silent Auxiliary	N	Worn as a wrist watch or pendant, the button(s) is/are programmed to trigger a silent Auxiliary panic . NOTE: Medical functionality has not been evaluated for UL/cUL, UKCA or CE/EN Grade 2.

KEYPAD

GROUP	NAME	SUPERVISED	SCENARIO
0	Fixed Intrusion	Y	Installed in a fixed location , the keypad is programmed to trigger a police panic . NOTE: Hold-up functionality has not been evaluated for UL/cUL, UKCA or CE/EN Grade 2.
1	Mobile Intrusion	N	Keypad can be mobile and is programmed to trigger a police panic
2	Fixed Silent	Y	Installed in a fixed location , the keypad is programmed to trigger a silent police panic
3	Mobile Silent	N	Keypad can be mobile and is programmed to trigger a silent police panic

KEYPAD

GROUP	NAME	SUPERVISED	SCENARIO
4	Fixed Auxiliary	Y	Installed in a fixed location such as night stand, the keypad is programmed to trigger an Auxiliary panic . NOTE: Medical functionality has not been evaluated for UL/cUL, UKCA or CE/EN Grade 2.
5	Fixed Silent Auxiliary	Y	Installed in a fixed location such as night stand, the keypad is programmed to trigger a silent Auxiliary panic . NOTE: Medical functionality has not been evaluated for UL/cUL, UKCA or CE/EN Grade 2.
6	Mobile Auxiliary	N	Keypad can be mobile and is programmed to trigger an Auxiliary panic . NOTE: Medical functionality has not been evaluated for UL/cUL, UKCA or CE/EN Grade 2.
7	Mobile Silent Auxiliary	N	Keypad can be mobile and is programmed to trigger a silent Auxiliary panic . NOTE: Medical functionality has not been evaluated for UL/cUL, UKCA or CE/EN Grade 2.

AUXILIARY PENDANT

*345 MHz auxiliary pendants can be programmed as “Loop” 1 only

GROUP	NAME	SUPERVISED	SCENARIO
0	Fixed Intrusion	Y	Installed in a fixed location such as under a desk, the button(s) is/are programmed to trigger a police panic
1	Mobile Intrusion	N	Worn or carried, the button(s) is/are programmed to trigger a police panic
2	Fixed Silent	Y	Installed in a fixed location such as under a desk, the button(s) is/are programmed to trigger a silent police panic
3	Mobile Silent	N	Worn or carried , the button(s) is/are programmed to trigger a silent police panic
4	Fixed Auxiliary	Y	Installed in a fixed location such as night stand, the button(s) is/are programmed to trigger an auxiliary panic
5	Fixed Silent Auxiliary	Y	Installed in a fixed location such as night stand, the button(s) is/are programmed to trigger a silent Auxiliary panic . NOTE: Medical functionality has not been evaluated for UL/cUL, UKCA or CE/EN Grade 2.
6	Mobile Auxiliary	N	Worn as a wrist watch or pendant, the button(s) is/are programmed to trigger an Auxiliary panic
7	Mobile Silent Auxiliary	N	Worn as a wrist watch or pendant, the button(s) is/are programmed to trigger a silent Auxiliary panic . NOTE: Medical functionality has not been evaluated for UL/cUL, UKCA or CE/EN Grade 2.
25	Safety Auxiliary Pendant	N	Used for local alerts like a nurse call button. Will not report an alarm to the Central Station. NOTE: Medical functionality has not been evaluated for UL/cUL, UKCA or CE/EN Grade 2.

*345 MHz smoke sensors will have the option to change the “Loop” number to 1, 2 or 3. This will allow the sensor to be programmed twice as 2 different zones where supported by the device

SMOKE DETECTOR/HEAT

GROUP	NAME	SUPERVISED	SCENARIO
26	Smoke-Heat	Y	Triggers an alarm when sensor detects smoke/rapid rise in heat

SMOKE-M

GROUP	NAME	SUPERVISED	SCENARIO
26	Smoke-Heat	Y	Triggers an alarm when sensor detects smoke or a rapid rise of heat. Use ONLY with Qolsys multi-sensor smoke (QS5110-840)

CO DETECTOR

*345 MHz carbon monoxide sensors can be programmed as “Loop” 1 only

GROUP	NAME	SUPERVISED	SCENARIO
34	CO	Y	Triggers an alarm when sensor detects Carbon Monoxide

HARDWIRE TRANSLATOR & WIRELESS TRANSLATOR

GROUP	NAME	SUPERVISED	SCENARIO
13	Takeover	Y	Triggers an alarm when sensor is tampered in "Stay" or "Away" mode

TILT

*345 MHz tilt sensors can be programmed as "Loop" 3 only

GROUP	NAME	SUPERVISED	SCENARIO
10	Entry-Exit- Normal Delay	Y	Triggers alarm after "normal delay" expires. Arms with both "Stay" and "Away"
12	Entry-Exit- Long Delay	Y	Triggers alarm after "long delay" expires. Arms with both "Stay" and "Away"
25	Garage Tilt- Safety Tilt	Y	This sensor group does not report or trigger an alarm. This is a chime only sensor when "Activity Monitoring" is active, regardless of panel status. Great for detached garage/shops. NOTE: Functionality in conjunction with garage door openers has not been evaluated for UL/cUL, UKCA or CE/EN Grade 2.

WATER

*345 MHz water sensors will have the option to change the “Loop” number to 1, 2 or 3. This will allow the sensor to be programmed twice as 2 different zones where supported by the device

GROUP	NAME	SUPERVISED	SCENARIO
38	Water Sensor	Y	Triggers an alarm when sensor detects presence of water. NOTE: flood sensor functionality has not been evaluated for UL/cUL, UKCA or CE/EN Grade 2.
25	Water Non-Reporting	Y	Used for local alerts. Will not report an alarm to the Central Station

Please note: When selecting “Water” you will see two additional options under “Sensor Sub-Type”: For IQ TempH2O (QS5500-PO1) & the IQ Flood (QS5516-840/QS5536-840) select “IQ Flood”; for all others, select “Other Flood”

SHOCK SENSOR

*345 MHz shock sensors will have the option to change the “Loop” number to 1 or 3. This will allow the sensor to be programmed twice as 2 different zones where supported by the device

GROUP	NAME	SUPERVISED	SCENARIO
13	Shock-Glass-Break	Y	Arms and trips shock sensors immediately when armed to both “Stay” and “Away”
17	Glass-Break-Away Only	Y	Arms and trips shock sensors immediately when armed only to “Away”

Please note: When selecting “Shock” you will see two additional options under “Sensor Sub-Type”: For IQ Shock select “IQ Shock”; for all others select “Other Shock”; *Power G Shock Sensor with prefix 170 offers additional sensitivity level functions

FREEZE

*345 MHz temp sensors can be programmed as “Loop” 1 only

GROUP	NAME	SUPERVISED	SCENARIO
52	Freeze	Y	Triggers an alarm when sensor detects low temperatures. NOTE: temperature sensor functionality has not been evaluated by UL/cUL
25	Freeze Non-Reporting	Y	Used for local alerts. Will not report an alarm to the Central Station

Please note: When using the PGx905 with Group 52, Freeze, the Low threshold setting is set to 40°F (4°C) by default. The Low threshold can be customized between -22°F and 158°F (-40°C and 85°C).

HIGH TEMPERATURE

GROUP	NAME	SUPERVISED	SCENARIO
53	Temp Reporting	Y	Triggers an alarm when sensor detects high temperatures. NOTE: temperature sensor functionality has not been evaluated by UL/cUL
25	Temp Non-Reporting	Y	Used for local alerts. Will not report an alarm to the Central Station

Please note: When using the PGx905 with Group 53, the High threshold setting is set to 100°F (38°C) by default. The High threshold can be customized between -22°F and 158°F (-40°C and 85°C).

DOOR BELL

GROUP	NAME	SUPERVISED	SCENARIO
25	Local Safety Sensor	Y	This sensor does not report or trigger an alarm. This is a chime only sensor when "Activity Monitoring" is active, regardless of panel status. Great to automate lights, cameras and notifications etc

SIREN

GROUP	NAME	SUPERVISED	SCENARIO
33	Siren	Y	Used for supervising Z-Wave sirens for wireless connectivity. Reports to the central station.
25	Local Safety Sensor	Y	Used for supervising Z-Wave sirens for wireless connectivity. Local supervision only. Does NOT report to the central station.

DOOR/WINDOW-M (For use only with Multi-function Door/Window Sensors)

GROUP	NAME	SUPERVISED	SCENARIO
10	Entry-Exit- Normal Delay	Y	Gives a period of time to exit the home or to disarm the panel when returning before sounding the alarm
12	Entry-Exit- Long Delay	Y	Gives a period of time to exit the home or to disarm the panel when returning before sounding the alarm. This can be a separate delay from the "normal delay"
13	Instant Perimeter D/W	Y	Door or window that triggers alarm instantly when system is armed
14	Instant Interior Door	Y	An interior sensor that triggers an alarm instantly while armed to both stay and away. Does not trip if an entry/exit sensor is tripped first
16	Away Instant- Follower Delay	Y	Interior door that triggers alarm instantly when system is armed to away mode only

DOOR/WINDOW-M (For use only with Multi-function Door/Window Sensors)

GROUP	NAME	SUPERVISED	SCENARIO
25	Local Safety Sensor	Y	This sensor does not report or trigger an alarm. This is a chime only sensor when "Activity Monitoring" is active, regardless of panel status. Used for medicine cabinets, chemical storage etc
8	Reporting Safety Sensor	Y	This sensor reports to the central station and triggers an alarm when "Activity Monitoring" is active, regardless of panel status
9	Delayed Reporting Safety Sensor	Y	This sensor reports to the central station and triggers an alarm when "Activity Monitoring" is active, regardless of panel status. This sensor has an entry delay

OCCUPANCY SENSOR

GROUP	NAME	SUPERVISED	SCENARIO
25	Local Safety Sensor	Y	This sensor group is to be used for monitoring activity in the home. This group does not report

TEMPERATURE

GROUP	NAME	SUPERVISED	SCENARIO
51	Temp Non Reporting	Y	Only for use with the PowerG Temp Sensor (PGx905). This sensor group does not report to the Central Station. Allows for actual temperature monitoring (thermometer) with customizable high/low threshold settings
52	Freeze	Y	Triggers an alarm when sensor detects low temperatures. NOTE: temperature sensor functionality has not been evaluated by UL/cUL
53	Temp Reporting	Y	Triggers an alarm when sensor detects high temperatures. NOTE: temperature sensor functionality has not been evaluated by UL/cUL

Please note: When using the PGx905 with Group 51, the High & Low threshold settings are set to 40°F and 100°F (4°C and 38°C) by default. When using Group 52, the Low threshold setting is set to 40°F (4°C) by default. When using Group 53, the High threshold setting is set to 100°F (38°C) by default. Thresholds can be customized between -22°F and 158°F (-40°C and 85°C).

SENSOR NAME

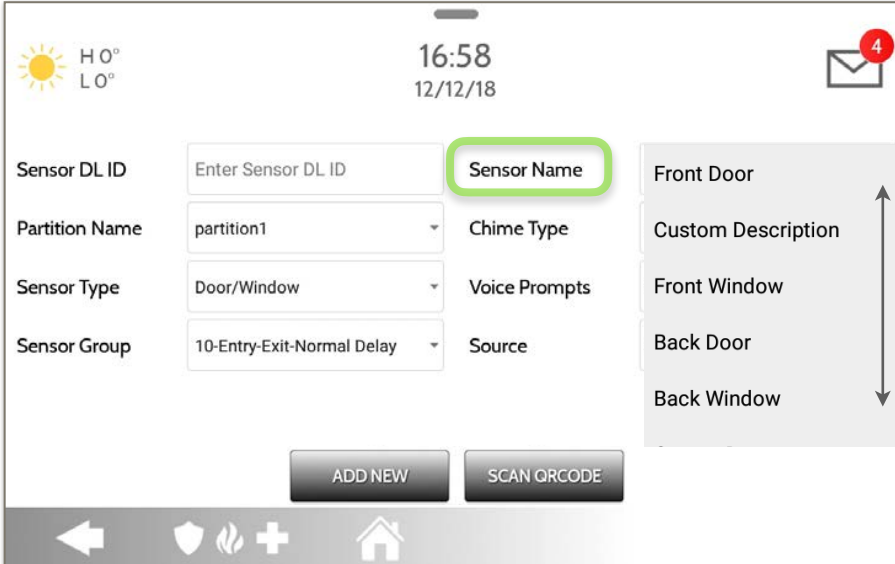

The screenshot displays a configuration screen for a security sensor. At the top, there is a weather icon, temperature (H 0°, L 0°), time (16:58), and date (12/12/18). A notification icon with a red '4' is in the top right. The main area contains several input fields: 'Sensor DL ID' (placeholder: Enter Sensor DL ID), 'Partition Name' (value: partition1), 'Sensor Type' (value: Door/Window), and 'Sensor Group' (value: 10-Entry-Exit-Normal Delay). To the right of these fields are labels for 'Sensor Name', 'Chime Type', 'Voice Prompts', and 'Source'. The 'Sensor Name' field is highlighted with a green border. A scrollable list of preset sensor names is shown on the right, including 'Front Door', 'Custom Description', 'Front Window', 'Back Door', and 'Back Window'. At the bottom, there are two buttons: 'ADD NEW' and 'SCAN QR CODE'. A navigation bar at the very bottom contains icons for back, home, and other functions.

When you select the sensor name field you can choose from a variety of preset sensor names by scrolling up and down or create a custom description.

SENSOR NAME: CUSTOM DESCRIPTION

When you select “Custom Description” as your sensor name the keyboard will appear. Type in the desired name (up to 56 characters) and click “Done.” The name will appear in the field below “Sensor Name.”

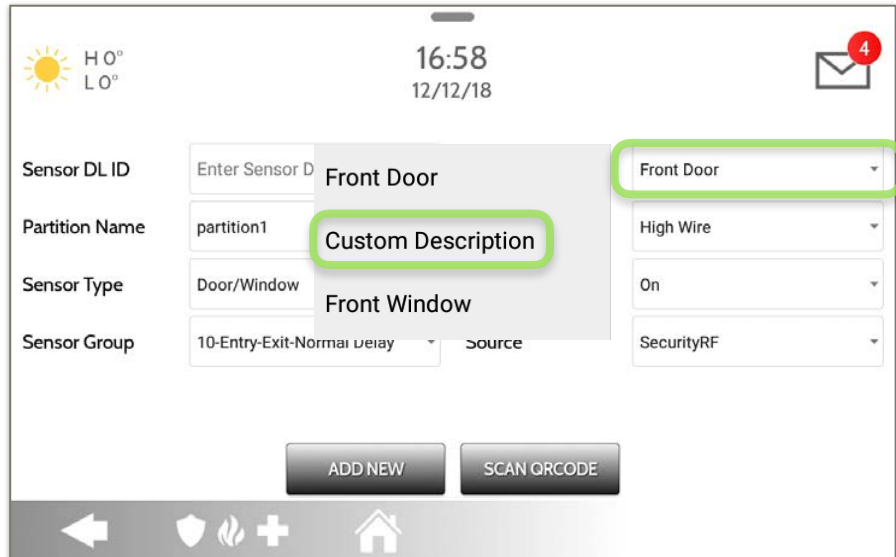

Screenshot of the Johnson Controls mobile app interface showing the sensor configuration screen. The screen displays the following fields and options:

- Sensor DL ID:** Enter Sensor D
- Partition Name:** partition1
- Sensor Type:** Door/Window
- Sensor Group:** 10-Entry-Exit-Normal Delay
- Sensor Name:** Front Door (highlighted with a green box)
- Custom Description:** Custom Description (highlighted with a green box)
- Sensor Type (Dropdown):** Front Window
- Sensor Group (Dropdown):** Source
- Sensor Type (Dropdown):** On
- Sensor Group (Dropdown):** SecurityRF

Buttons at the bottom: ADD NEW, SCAN QR CODE.

Bottom navigation bar: Back arrow, Shield, Fire, Plus, Home icon.

Top status bar: Sun icon, H 0° L 0°, 16:58, 12/12/18, Notification icon (4).

CHIME TYPE

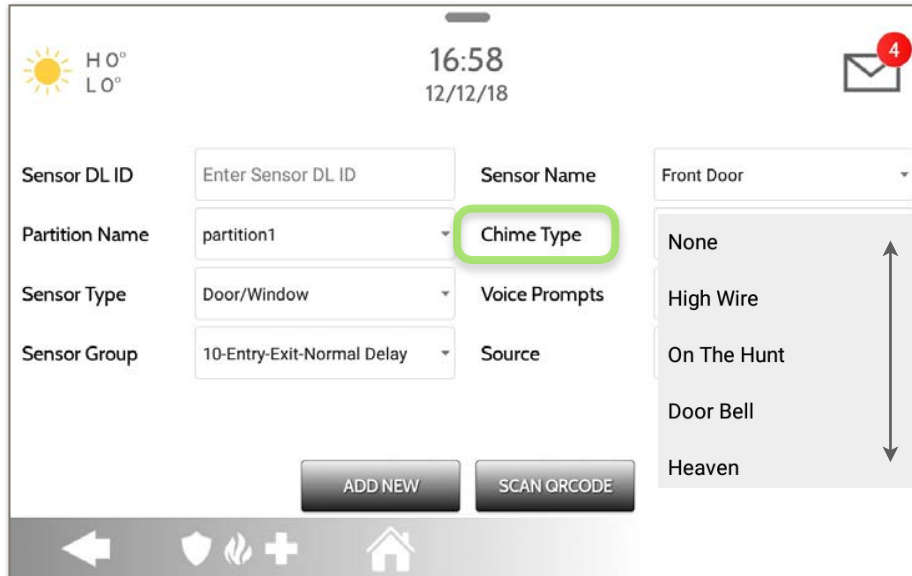

The screenshot shows a mobile application interface for configuring a security sensor. At the top, there is a weather widget showing a sun icon, 'H 0°', 'L 0°', the time '16:58', and the date '12/12/18'. A notification icon with a red bubble containing the number '4' is in the top right. The main configuration area has several fields: 'Sensor DL ID' (text input with placeholder 'Enter Sensor DL ID'), 'Sensor Name' (dropdown menu showing 'Front Door'), 'Partition Name' (dropdown menu showing 'partition1'), 'Sensor Type' (dropdown menu showing 'Door/Window'), and 'Sensor Group' (dropdown menu showing '10-Entry-Exit-Normal Delay'). The 'Chime Type' dropdown menu is highlighted with a green circle and is open, displaying a list of options: 'None', 'High Wire', 'On The Hunt', 'Door Bell', and 'Heaven'. A vertical double-headed arrow is positioned to the right of the list. At the bottom, there are two buttons: 'ADD NEW' and 'SCAN QR CODE'. A navigation bar at the very bottom contains icons for back, shield, fire, plus, and home.

Because of the dynamic nature of the way the IQ Panel 4 pairs and understands each individual sensor, you can program each sensor to have a unique chime or even turn chiming off for that individual sensor. To customize your chime for a particular sensor touch the Chime Type drop down and choose from the list.

VOICE PROMPTS

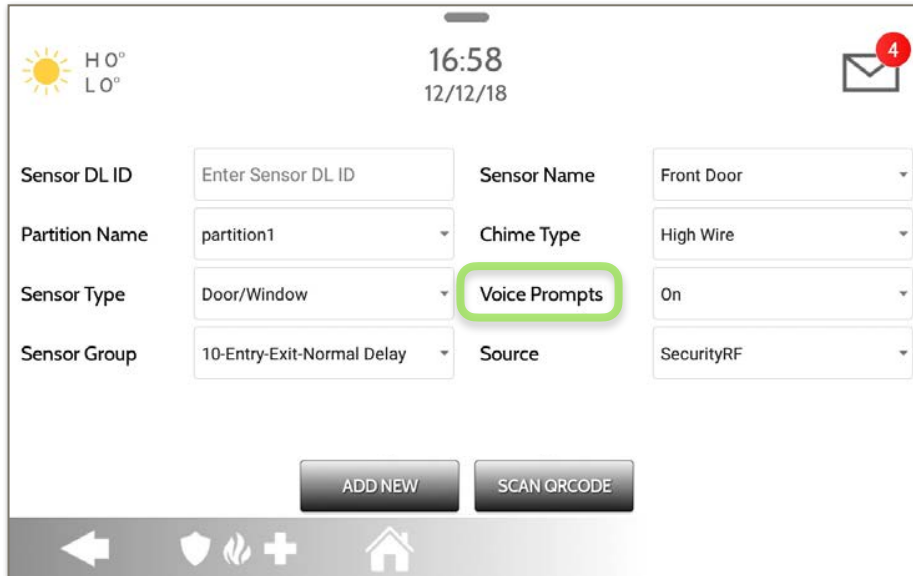

The screenshot shows a mobile application interface for configuring a sensor. At the top, there is a weather icon, temperature (H 0°, L 0°), the time (16:58), and the date (12/12/18). A notification icon with a red circle containing the number '4' is in the top right. The main configuration area consists of several rows of labels and input fields:

- Sensor DL ID:** Enter Sensor DL ID
- Partition Name:** partition1
- Sensor Type:** Door/Window
- Sensor Group:** 10-Entry-Exit-Normal Delay
- Sensor Name:** Front Door
- Chime Type:** High Wire
- Voice Prompts:** On (This dropdown menu is highlighted with a green box)
- Source:** SecurityRF

At the bottom of the configuration area are two buttons: "ADD NEW" and "SCAN QR CODE". The bottom navigation bar contains icons for back, shield, fire, plus, and home.

Voice prompts announce the sensor name when the sensor is opened or tripped.*

For door/window sensors, voice prompts are defaulted to “On”. For most other sensors the default is “Off.” Touch the drop down menu to change.

Choose individually which sensors should have voice prompts ON or OFF

***NOTE:** “Activity Monitoring Sensors” will also audibly report when they have been closed.

SOURCE

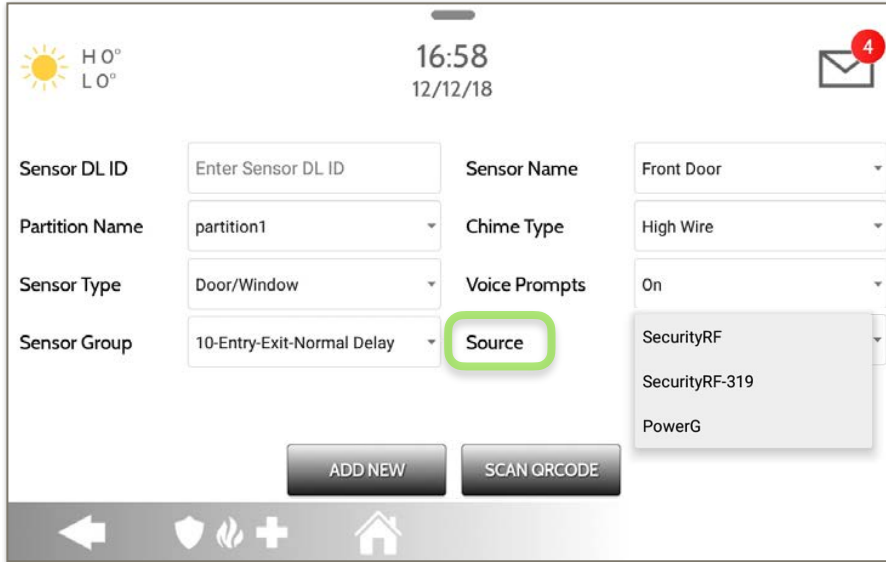

The screenshot shows a configuration screen for a security sensor. At the top, there is a weather icon, temperature range (H 0°, L 0°), the time 16:58, and the date 12/12/18. A notification icon with the number 4 is in the top right. The form contains several fields:

- Sensor DL ID: Enter Sensor DL ID
- Partition Name: partition1
- Sensor Type: Door/Window
- Sensor Group: 10-Entry-Exit-Normal Delay
- Sensor Name: Front Door
- Chime Type: High Wire
- Voice Prompts: On
- Source: (highlighted with a green circle, dropdown menu open showing SecurityRF, SecurityRF-319, and PowerG)

At the bottom, there are buttons for 'ADD NEW' and 'SCAN QR CODE', and a navigation bar with icons for back, shield, fire, plus, and home.

Source indicates the sensor's incoming frequency when pairing to the IQ Panel 4.

The following options will be available depending on the pre-installed RF Daughter Card:

- PowerG
- SecurityRF
- SecurityRF-319
- S-Line
- SecurityRF-345
- 345RF 2G
- SecurityRF-433
- Zigbee

NOTE: PowerG modem radio cards are used also in UL/ULC listed Commercial burglary applications. SRF319, SRF433 (DSC Protocol), PowerG modem, Zigbee and SRF345 radio cards are used in UL/ULC listed Residential fire and burglary applications. SRF433 (AT&T Digital Life protocol) modem radio cards are used only in UL listed Residential fire and burglary applications. Zigbee and SRF433 are not for EN Grade 2, SRF319, SRF345 are not for UKCA or CE/EN Grade installations.

EDIT SENSOR



Edit Sensor

Edit sensors after they have already been learned in. All fields can be edited with the exception of the DL or Sensor ID.

NO	PTID	ID	SIGNAL SOURCE	TYPE	NAME	GROUP	EDIT
1	1	12BEA1	G	Motion	Upstairs Motion Detector	17-Away-Instant Motion	
2	1	12BEA2	G	Motion	Downstairs Motion Detector	17-Away-Instant Motion	
3	1	12BEA3	G	Door/Window	Front Door	10-Entry-Exit-Normal Delay	
4	1	12BEA4	G	Door/Window	Laundry Door	10-Entry-Exit-Normal Delay	
5	1	12BEA5	G	Door/Window	Back Door	13-Instant Detector DAW	

To make changes to a sensor, touch the “Pencil” icon next to the sensor that needs editing. Change desired fields and then touch “SAVE”.

FIND IT

Swipe down for access

- SETTINGS
- ADVANCED SETTINGS
- ENTER CODE (1111, 2222)
- INSTALLATION
- DEVICES
- SECURITY SENSORS
- EDIT SENSOR

DELETE SENSOR



Delete Sensor

Delete each sensor individually or choose to delete more than one at a time. This is useful when needing to replace a sensor all together instead of simply editing programmed information.

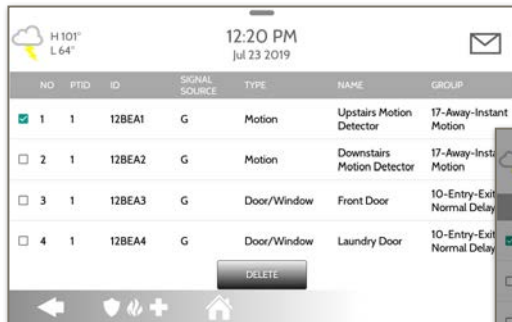

Select the sensor(s) from the list that are to be deleted and then touch “DELETE”

Verify that the action is correct and touch “OK” to confirm or “CANCEL” to quit the operation

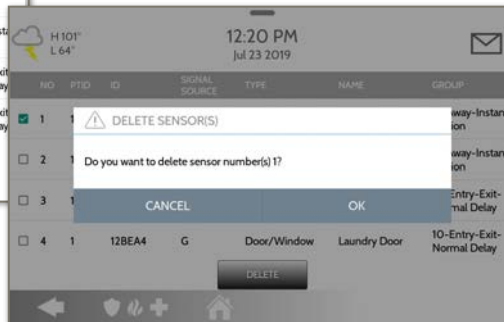

FIND IT

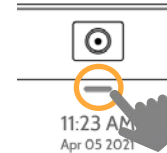

Swipe down for access



SETTINGS



ADVANCED SETTINGS



ENTER CODE (1111, 2222)



INSTALLATION



DEVICES



SECURITY SENSORS



DELETE SENSOR

SENSOR STATUS



Sensor Status

Monitor sensor status in real time for things like open, close, tamper, idle and low battery.

NO	PTID	ID	SIGNAL SOURCE	NAME	TYPE	GROUP	STATUS
1	1	12BEA1	G	Upstairs Motion Detector	Motion	17-Away-Instant Motion	Idle
2	1	12BEA2	G	Downstairs Motion Detector	Motion	17-Away-Instant Motion	Idle
3	1	12BEA3	G	Front Door	Door/Window	10-Entry-Exit-Normal Delay	Closed
4	1	12BEA4	G	Laundry Door	Door/Window	10-Entry-Exit-Normal Delay	Closed
5	1	12BEA5	G	Back Door	Door/Window	13-Instant Perimeter DAW	Open

This page also allows you to quickly review programming for things like Zone number, Partition, Signal Source (319, 345, 433, PowerG, Native or Zigbee), Sensor Name, Sensor Type and Sensor Group.

FIND IT

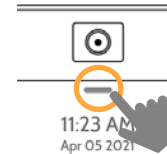

Swipe down for access

- SETTINGS
- ADVANCED SETTINGS
- ENTER CODE (1111, 2222)
- INSTALLATION
- DEVICES
- SECURITY SENSORS
- SENSOR STATUS

SENSOR GROUP



Sensor Group

Don't have this manual handy on an install? Sensor Group gives you digital access to view each possible sensor group and its behaviors directly on the panel.

ID	TYPE	NAME	SUPERVISORY	RESTORAL	TIMER	SIREN TYPE
0	Auxiliary Pendant	Fixed Intrusion	Y	N	Immediate	Siren3
1	Auxiliary Pendant	Mobile Intrusion	N	N	Immediate	Siren3
2	Auxiliary Pendant	Fixed Silent	Y	N	Immediate	Siren3
4	Auxiliary Pendant	Fixed Auxiliary	Y	N	Immediate	Siren3
6	Auxiliary Pendant	Mobile Auxiliary	N	N	Immediate	Siren3

The Sensor Group list is sorted by "Type" in alphabetical order from A - Z.

FIND IT

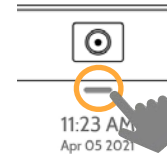

Swipe down for access

- SETTINGS
- ADVANCED SETTINGS
- ENTER CODE (1111, 2222)
- INSTALLATION
- DEVICES
- SECURITY SENSORS
- SENSOR GROUP

PANEL MOTION SETTINGS



Panel Motion Settings

Control settings for the built-in Panel Motion Detector. Change the sensitivity threshold and mask off up to 4 customizable areas to prevent false triggers.

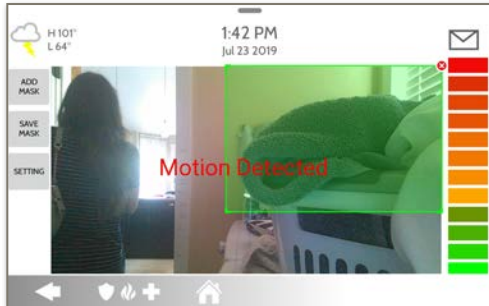

Masking:



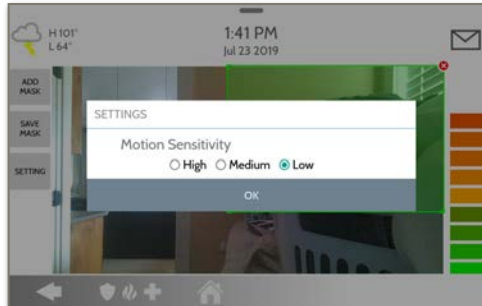





Touching "ADD MASK" will give a drawable area (green) that is not taken in to account for motion pixelation change, then touch "SAVE MASK" to save. Up to 4 independent mask areas can be drawn.



Sensitivity Setting:

Touch "SETTING" to change the the Panel Motion sensitivity between Low (default), Medium and High. Use the Green to Red bar on the right side of the screen to determine trigger threshold.

FIND IT

-  Swipe down for access
-  11:23 AM
Apr 05 2021
-  SETTINGS
-  ADVANCED SETTINGS
-  ENTER CODE (1111, 2222)
-  INSTALLATION
-  DEVICES
-  SECURITY SENSORS
-  PANEL MOTION SETTINGS

WI-FI DEVICES

WI-FI DEVICES



Wi-Fi Devices

View and remove Wi-fi devices associated with the panel as well as configure the Qolsys Access point.



Wi-Fi

Scan and connect to a Wi-Fi network. This will ensure your panel can receive software updates and have a Dual Path connection.



Access Point Settings

Configure the IQ Panel 4's built in router. Enable/Disable the router, broadcast or hide the SSID and change the SSID's password etc...



Access Point Connected Devices

View connected device information such as IP, MAC address and for how long the device has been connected.



IQ Remote Devices

Pair an IQ Remote Secondary Touchscreen to the panel whether it is connected to the customer's network or the panel's built in Access Point.



3rd Party Connections

Enable or disable 3rd party connections on the panel. This feature is used for specific 3rd party device integration

FIND IT

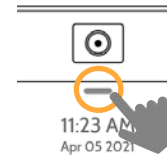

Swipe down for access



SETTINGS



ADVANCED SETTINGS



ENTER CODE (1111, 2222)



INSTALLATION



DEVICES



WI-FI DEVICES

WI-FI DEVICES



IQ WiFi

Connect to and Manage IQ WiFi
and IQ WiFi 6 routers

CONNECTING TO WI-FI



To connect to a Wi-Fi network, follow the steps below:

Swipe down from the top menu bar and select settings.



Touch Advanced Settings (Installer Code)



Then touch "Wi-Fi"



Enable Wi-Fi if not already active

Available networks appear in a list. Touch the desired network and use the keyboard to type the password (if required).

Note: Frequency, PMF and more can be changed under Advanced Settings

Activate WIFI



Qolsys-5G
Connected



Now Communications



Qolsys



Sunset Room



Vertical Ops 2.4

+ Add wi-fi network

FIND IT

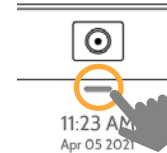

Swipe down for access



SETTINGS



ADVANCED SETTINGS



ENTER CODE (1111, 2222)



INSTALLATION



DEVICES



WI-FI DEVICES

ACCESS POINT SETTINGS

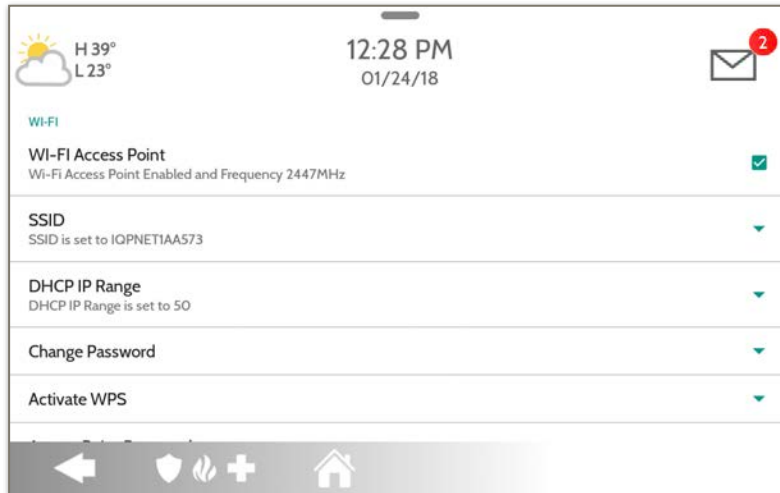

WI-FI Access Point:

Enable or Disable the Panel Access Point

SSID:

Change the SSID Name. This is the name that other devices will use to connect to.

DHCP IP Range:

Modify the DHCP IP Range for the access point. Default is 50.

Change Password:

Change the password of the SSID to one of your choosing.

Activate WPS:

Connect devices to the panel's built-in access point using WPS push button.

Access Point Password:

Shows current password in use for the Panel Access Point

ACCESS POINT CONNECTED DEVICES



NO	MAC ADDRESS	IP ADDRESS	CONNECTED TIME(MM:DD:HH:MM)	ACTIONS
1	00:02:d1:42:19:48	192.168.50.80	00:00:00:04	<input type="checkbox"/>

View the IP address, Mac address and connected duration of each Wi-Fi client connected to the panel's built in router.

Select "Actions" to then remove a device that has been associated with the panel.

You must remove saved network information from the device otherwise it will re-connect to the panel.

IQ REMOTE DEVICES



IQ Remote Devices

Pair up to 3 IQ Remote Secondary Touchscreens to the panel via the customer's network or the panel's built in access point.

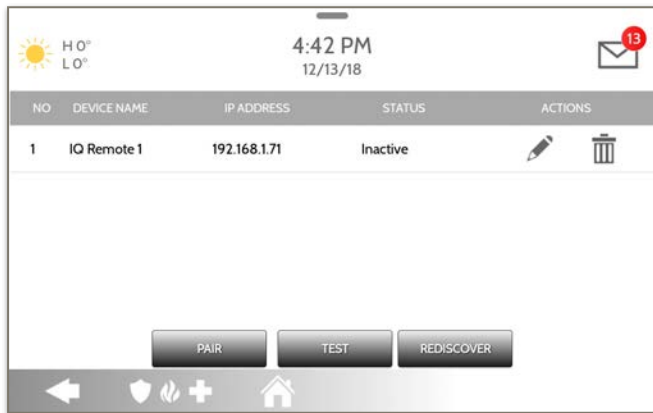

NOTE: The IQ Remote will automatically pair as Sensor Type “Keypad” and will appear on the zone list in the order in which it is paired. Sensor Groups 0, 1 & 2 are available options for this Sensor Type.

1. Connect the IQ Remote to the panel's access point or to the same Wi-Fi network the panel is connected to. **NOTE:** QW9102 & QW9103 IQ Remotes only support 2.4 GHz networks. QW9104 IQ Remotes support both 2.4 GHz and 5 GHz.
2. Prior to pairing the IQ Remote to the panel you can Test the connection by select TEST on the panel and the remote.
3. Select “Pair” on the Panel and then Pair on the IQ Remote to begin during this process the remote will also download and update to the current software version and reboot.
4. The remote device will pair to the panel and will show that it is active on the list. You can then edit (device name and sensor group), ping, delete or rediscover the device if necessary

3RD PARTY CONNECTIONS

Note: Not authorized for EN Grade 2 installations



3rd Party Connections

Enable or disable 3rd party connections on the panel. This feature is used for specific 3rd party device integration

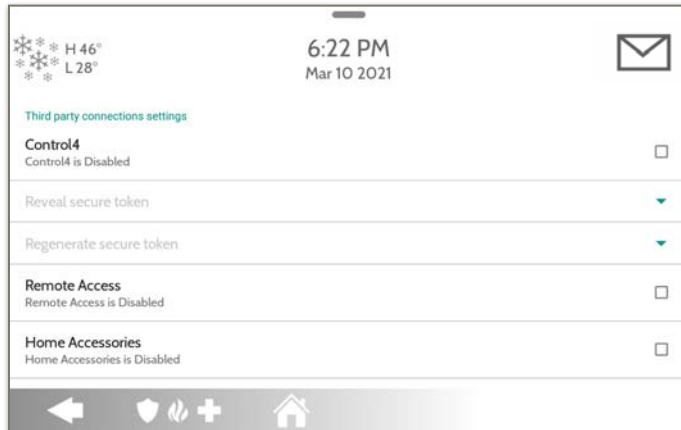

Check the “Control4” box to enable 3rd Party Connections. This will cause the panel to reboot in order to apply the change. Once enabled a secure token can be generated in order to sync with Control4 integration.

Remote Access, Home Accessories and Savant are reserved for future use.

FIND IT

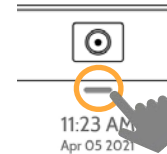

Swipe down for access

- SETTINGS
- ADVANCED SETTINGS
- ENTER CODE (1111, 2222)
- INSTALLATION
- DEVICES
- WI-FI DEVICES
- 3RD PARTY CONNECTIONS

IQ WIFI



IQ WiFi

Connect to and Manage IQ WiFi and IQ WiFi 6 routers.







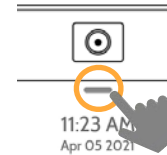

Manage the SSID, Password, Guest Network, Security Reconnect, IQ WiFi Profile, Dashboard and more on the IQ WiFi and IQ WiFi 6.

You can also check for a router update, view the devices connected to the network and the network signal strength between nodes.

FIND IT



Swipe down for access

-  SETTINGS
-  ADVANCED SETTINGS
-  ENTER CODE (1111, 2222)
-  INSTALLATION
-  DEVICES
-  WI-FI DEVICES
-  IQ WIFI

Z-WAVE DEVICES

Z-WAVE DEVICES

Note: Not authorized for EN Grade 2 installations



Z-Wave Devices

Add, Edit, Clear and Remove Z-Wave Devices. You can also View/Edit associations as well as access Z-Wave Settings.



Add Device (Inclusion)

Add new devices to the Z-Wave network



Edit Device

Make changes to existing devices



Clear Device (Exclusion)

Removes a Z-Wave device from its previous network. Also deletes a device from the IQ Panel 4 if currently paired.



Delete Failed Device

Remove a failed Z-Wave device from the IQ Panel 4's memory



Remove All Devices (Factory Default Reset)

If this controller is the primary controller for your network, resetting it will result in the nodes in your network being orphaned and it will be necessary after the reset to exclude and re-include all of the nodes in the network. If this controller is being used as a secondary controller in the network, use this procedure to reset this controller only in the event that the network primary controller is missing or otherwise inoperable.



View/Edit Associations

Manually change Z-Wave associations for specific devices.



Z-Wave Settings

Configure device limits and other Z-Wave settings.



SmartStart

Enter the device's DSK or simply scan the QR Code.



Provisioning List

Devices added via SmartStart will show their progress of being included into the network.

ADD DEVICE



1. Select “Add Device”



INCLUDE

2. Touch “Include”

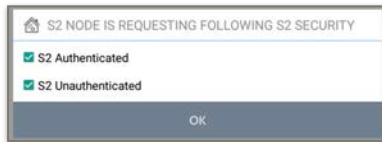

3. Press the “Pair” or “Learn” button on the device when the message appears. *(see individual device documentation for instructions on button location)*

4. Adjust the device name by touching and making the appropriate selections.

5. Select “Automation” to enable simple light rules.

- **Night:** Turns light on at 7pm and off at 6am
- **Evening:** Turns light on at 7pm and off at 11pm
- **Front Door:** Turns light on for 15mins when Front Door opens (must have a sensor with the default quick name “Front Door” added in the panel).

6. Click “Add” to save the information and complete the process. (Adjustments can be made later from “Edit Device” icon)



S2 is a new Z-Wave Security Protocol. When an S2 node is attempting to be included it will request S2 security keys. These are based on the level of S2 security that the end device requires. These keys can be Unauthenticated, Authenticated or Access. These keys can be manually granted by selecting the appropriate option.

FIND IT

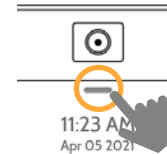

Swipe down for access



SETTINGS



ADVANCED SETTINGS



ENTER CODE (1111, 2222)



INSTALLATION



DEVICES



Z-Wave DEVICES



ADD DEVICE

CLEAR DEVICE



Clears Z-Wave device from a network, whether it was enrolled with another controller previously or the IQ Panel 4. Also deletes a device from the IQ Panel 4 if currently paired.



Touch
“Clear Device”

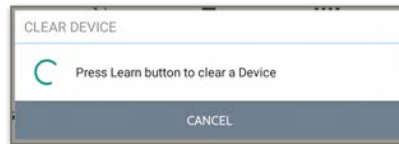

Panel will start sending a
“Clear” signal



Press
“Pair” or “Learn”
button on device*

Panel returns to
Z-Wave Device
menu when
complete

NOTE: Each Z-Wave device is different, and not all devices have a hard button to pair or learn. Refer to your device’s installation manual for specifics on pairing or learning.

DELETE FAILED DEVICE



Deletes Z-Wave device from the panel. Before adding the device to another network see instructions on how to “Exclude” a Z-Wave device. Only allows a Node ID to be deleted if it has failed and is no longer communicating.



Touch
“Delete Failed
Device From
Panel”

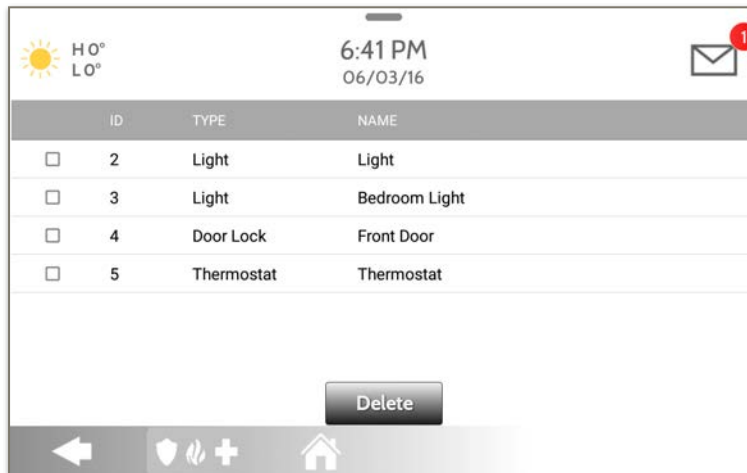

ID	TYPE	NAME	
<input type="checkbox"/>	2	Light	Light
<input type="checkbox"/>	3	Light	Bedroom Light
<input type="checkbox"/>	4	Door Lock	Front Door
<input type="checkbox"/>	5	Thermostat	Thermostat

Check the boxes next to the device(s) you want to delete



Touch “Delete”

REMOVE ALL DEVICES



Deletes all Z-Wave devices from the panel and resets the panel's Z-Wave controller.

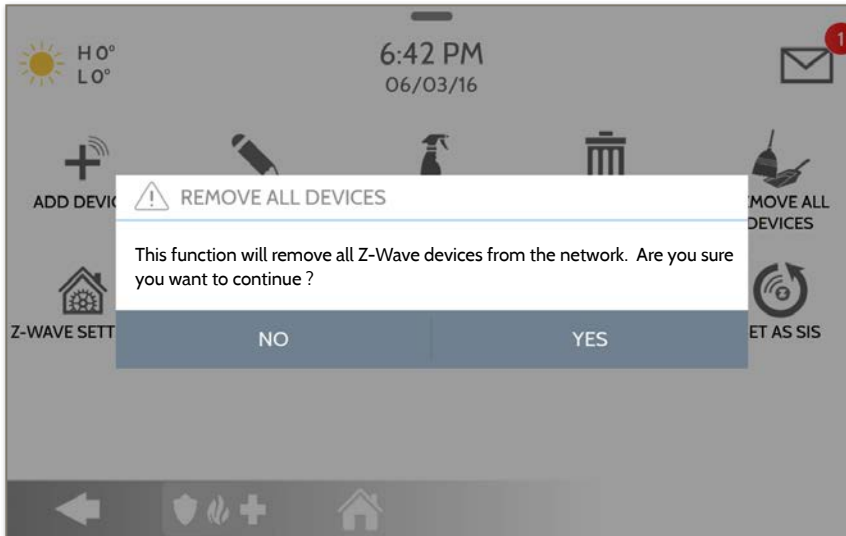

Touching "Remove All Devices" brings a confirmation pop-up asking you to confirm your decision to remove all devices.

If this controller is the primary controller for your network, resetting it will result in the nodes in your network being orphaned and it will be necessary after the reset to exclude and re-include all of the nodes in the network. This procedure will send a "Device Reset Locally" to all Z-Wave devices in the IQ Panel 4's Lifeline Group (Group 1).

VIEW/EDIT ASSOCIATIONS



Manually change Z-Wave associations for specific devices.

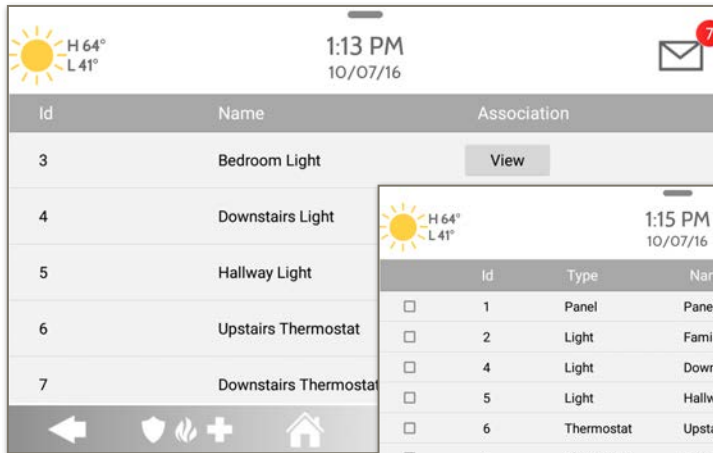

1. Select the Z-Wave device you would like to associate with another by touching "View"

2. Select "Edit"



3. "Check" the boxes next to each device that you would like to associate with. Then select "Save"



Note: The IQ Panel 4 supports Lifeline in Group 1 to send out Device Reset Locally when it has been associated to another Z-Wave Plus device. This is triggered when "REMOVE ALL DEVICES" is used

Z-WAVE SETTINGS

Z-Wave Settings allow an installer to set a maximum number of Z-Wave devices allowed on the IQ Panel 4 in all categories and to control other Z-Wave settings.

Device	Default	Maximum Number Supported
Thermostats	40	Maximum number of supported Thermostats is 40
Lights	80	Max number of supported Z-Wave light modules is 80
Door Locks	20	Maximum number of supported Z-Wave Door Locks is 20
Other Z-Wave Devices	21	Maximum number of misc Z-Wave devices is 21
Garage Doors	6	Maximum number of Garage Doors is 6
Allow Master Code Z-Wave Settings	Disabled	Allow Master User Code to access Z-Wave Settings
Allow Master Code Z-Wave Management	Disabled	Allow Master User Code to access Z-Wave Devices (Add, Edit, Clear, Delete Failed Device, Remove All Devices & View/Edit Associations)





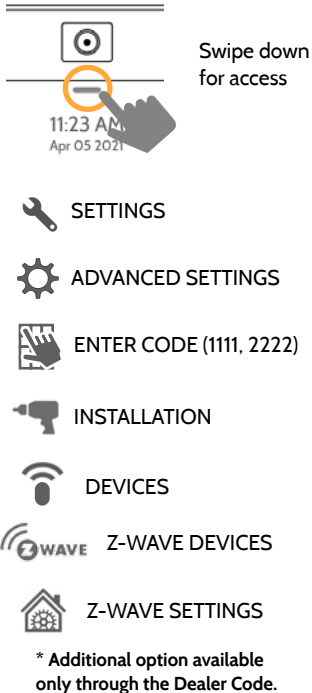

NOTE: This feature has not been evaluated by UL/cUL. This is a supplementary functionality that will not interfere with the minimum mandatory operation of the life safety and burglary protection of the alarm system control unit. UL Note: Additional Z-Wave devices other than what has been indicated as maximum limits have not been evaluated by UL/cUL.

FIND IT



Swipe down for access

11:23 AM
Apr 05 2021

-  SETTINGS
-  ADVANCED SETTINGS
-  ENTER CODE (1111, 2222)
-  INSTALLATION
-  DEVICES
-  Z-WAVE DEVICES
-  Z-WAVE SETTINGS

* Additional option available only through the Dealer Code.

Z-WAVE SETTINGS

Setting	Default	Description
Access to Automation	Enabled	When enabled it allows the ability to apply simple automated actions to lights and switches directly from the panel
Z-Wave	Enabled	Activate or deactivate the Z-Wave radio. Please use this procedure only when the controller (panel) is missing or inoperable
Zwave Frequency Region	Varies by Region	Sets automatically based on install region and Z-Wave hardware installed in the panel or manually choose between United States, European Union, Australia/New Zealand, Hong Kong, Malaysia, India, Israel, Russia, China, Japan or Korea.
Advanced Z-Wave Settings	Disabled	When Advanced Z-Wave Settings is enabled the following new icons will appear on the Z-Wave Devices page: <ul style="list-style-type: none"> - Replace Failed Node: Allows a node that has failed to be replaced with a new device using the same node ID - Add/Remove Controller: This icon acts like an “Add/Remove” button when pairing the IQ Panel into another network

SMARTSTART



1. Select “SmartStart”



2. Touch “Include”



3. Scan the Box or Device’s QR code or manually enter the DSK code and select Add DSK.

4. Adjust the device name by touching and making the appropriate selections.

5. Select “Automation” to enable simple light rules.

- **Night:** Turns light on at 7pm and off at 6am
- **Evening:** Turns light on at 7pm and off at 11pm
- **Front Door:** Turns light on for 15mins when Front Door opens (must have a sensor with the default quick name “Front Door” added in the panel).

6. Click “Add” to save the information and complete the process. (Adjustments can be made later from “Edit Device” icon)



FIND IT

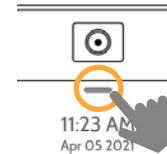

Swipe down for access



SETTINGS



ADVANCED SETTINGS



ENTER CODE (1111, 2222)



INSTALLATION



DEVICES



Z-WAVE DEVICES



SMARTSTART

PROVISIONING LIST



Provisioning List

Devices added via SmartStart will show up in the provision list. This list will show the network status of those devices. Once a device reaches the “Included” state on the panel, it can no longer be deleted using the trash can method and must follow standard clearing process.



DSK	TYPE	NAME	NETWORK STATUS
49036	Light	Light	Not in network

NETWORK STATUS:

Not in network: When a device has been paired but has not yet been plugged in it will show Not in Network. These devices can also be deleted using the trash can.

Started: Once the device has been paired and then plugged in, it will start the inclusion process with the panel and run in the back ground.

Included: When a device has completed the inclusion process it will then show as “included” in the provisioning list and at that point the panel’s UI will reflect the included devices.

BLUETOOTH DEVICES

BLUETOOTH DEVICES



Bluetooth Devices

Add, Edit, Delete and Configure a Bluetooth Device. Bluetooth disarm supported via a mobile device.



Add Phone

Pair up to 5 mobile Bluetooth devices.



Edit Device

Make changes to existing Bluetooth devices.



Delete Device

Delete a paired Bluetooth device



Remove All Devices

Removes all paired Bluetooth devices at once.



Settings

Toggle Bluetooth on/off, adjust Bluetooth disarm settings and change Bluetooth disarm timeout (1,5,10,20 & 30mins).

FIND IT

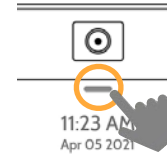

Swipe down for access



SETTINGS



ADVANCED SETTINGS



ENTER CODE (1111, 2222)



INSTALLATION





DEVICES

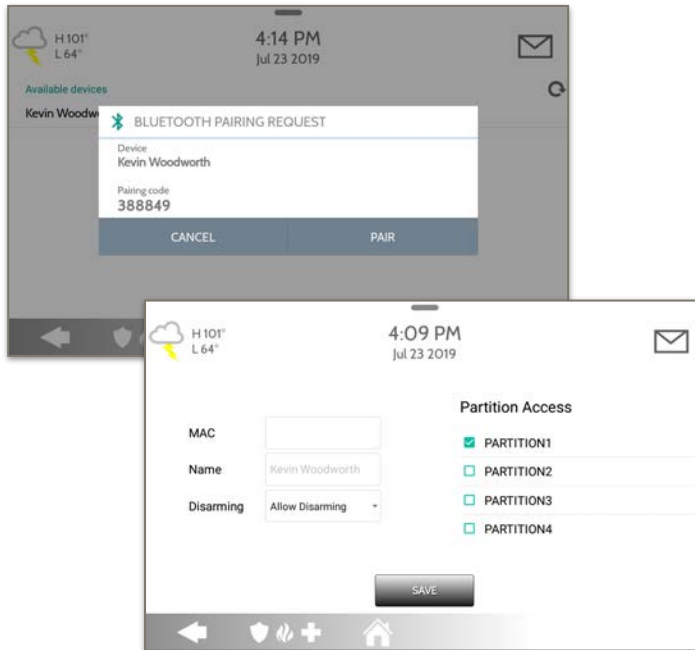

BLUETOOTH DEVICES

ADD PHONE



1. Select “Add Phone” 
2. Open the Bluetooth page on your mobile device. The panel will search for all available and in range Bluetooth devices.
3. Select the correct device from the list on the panel and ensure the pairing code matches that on your mobile device.
4. Touch “Pair” on the panel first, and then on your mobile device.
5. Choose whether to allow disarming or not, and select the Partition to be disarmed (if Partitions are enabled).
6. Your mobile device will now show under the “Paired Devices” list on the panel.

NOTE: Your phone may show the IQ Panel as “Not Connected”. This is normal

EDIT DEVICE

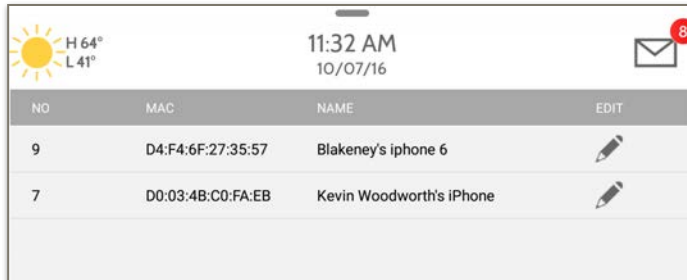

NO	MAC	NAME	EDIT
9	D4:F4:6F:27:35:57	Blakeney's iphone 6	
7	D0:03:4B:C0:FA:EB	Kevin Woodworth's iPhone	

1. Select the pencil next to the device you would like to edit.

2. Select whether or not you would like to allow a device to disarm the panel when in proximity.

3. Select which Partition you would like the device to disarm.

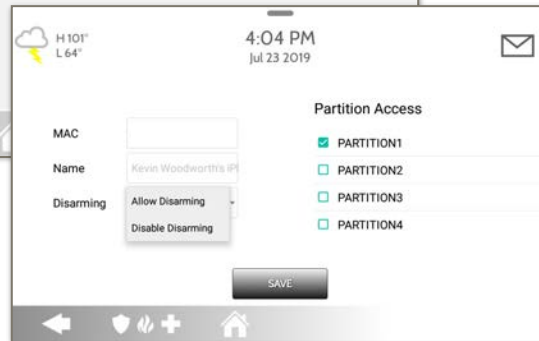

MAC:

Name: Kevin Woodworth's iPhone

Disarming:

Partition Access

- PARTITION1
- PARTITION2
- PARTITION3
- PARTITION4

Note: This option is only available when “Partitions” are enabled. A device can only be assigned to one Partition at a time.

DELETE DEVICE

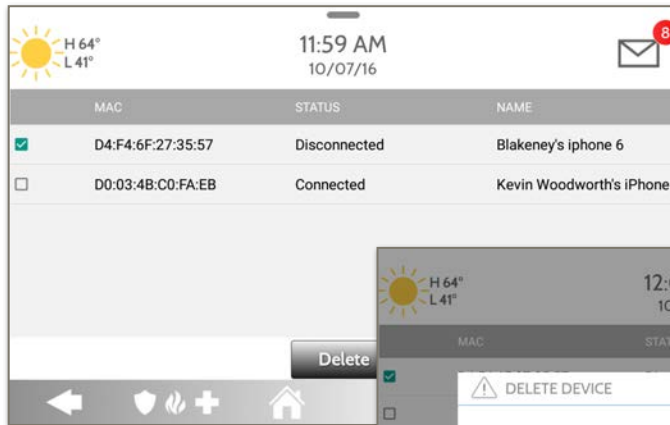

1. Select the check box next to the device you would like to delete.

2. Select "Delete" at the bottom of the page.

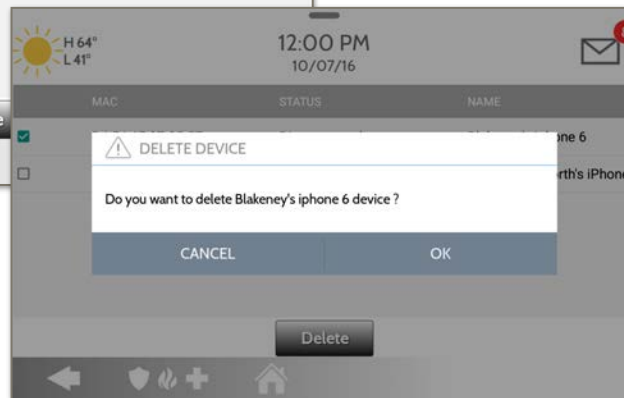

3. Select "OK" to confirm and delete the device.

REMOVE ALL DEVICES

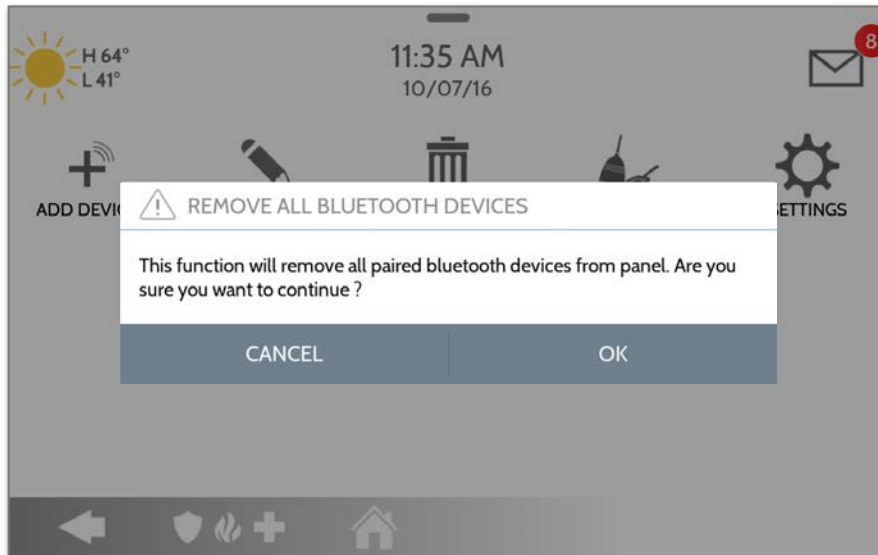

To delete and remove all enrolled Bluetooth devices at once, select “Remove All Devices”.

Next select “OK” to confirm you would like to delete.

SETTINGS

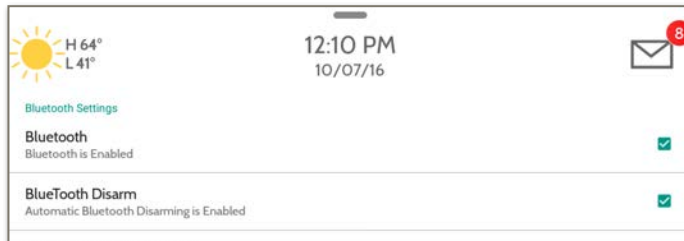

BLUETOOTH:

Select or un-select this box to enable or disable the Bluetooth radio.

BLUETOOTH DISARM:

Select or un-select this box to enable or disable the ability to disarm the panel via Bluetooth. To change this on an individual level you must edit the specific device.

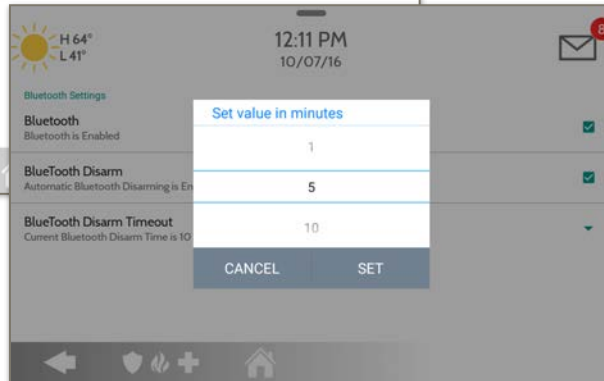

BLUETOOTH DISARM TIMEOUT:

Change the time in which the panel must wait after it's been armed to away before it allows a Bluetooth device to disarm it. **Default 10 min**

Select from 1, 5, 10, 20 or 30 minute disarm timeout

SYSTEM TESTS

SYSTEM TESTS



System Tests

There are many different tests you can perform to ensure the system is working properly.



Wi-Fi Test

Test the panel's connection to the wireless (Wi-Fi) network



Sensor Test

Shows actual dBm signal strength of each sensor and graphs sensor events against the ambient noise floor of the environment



Cellular Test

Test the panel's connection to the cellular network and Alarm.com



Z-Wave Tests

Test communication between devices and the panel. Rediscover network, counters, neighbor info, diagnostics & advanced diagnostics



PowerG Test

Ping and receive simple signal strength from a PowerG sensor.



PowerG Signal Strength

Graphs and shows dBm signal strength for PowerG sensors.

FIND IT

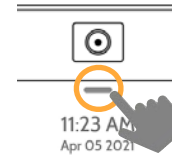

Swipe down
for access



SETTINGS



ADVANCED SETTINGS



ENTER CODE (1111, 2222)



SYSTEM TESTS

SYSTEM TESTS



Zigbee Test

See the last signal strength, average signal strength and battery voltage on Zigbee sensors. Requires a Zigbee daughter card be installed in order for this icon to appear



Panel Glass Break Test

Test the panel's microphones to ensure proper sensitivity for built in Glass Break



Dual Path Test

Verifies the Wi-Fi path is connecting to Alarm.com

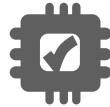

Daughter Cards Test

Tests the integrity of the installed daughter cards



Panel Test

Runs through a complete test of the panel's running processes



Ambient Noise Test

Run a test to better understand if the Ambient Noise Detector is likely to trip.



Input Voltage Test

Measure the voltage received at the Panel in real-time

FIND IT

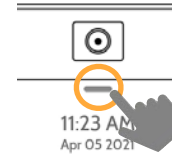

Swipe down for access



SETTINGS



ADVANCED SETTINGS



ENTER CODE (1111, 2222)



SYSTEM TESTS

WI-FI TEST



Wi-Fi Test

The Wi-Fi test checks the IQ Panel 4's connection to your network (router). Before running this test, be sure to connect the panel to the network. See "customization" section for directions on connecting to Wi-Fi.









A successful test will result in a "pass" and indicates the date and time of the test along with connection speed.

To perform a Wi-Fi Test, touch the "Run" button.

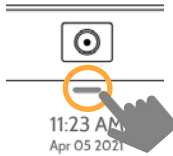

NOTE: If test fails, please check your Wi-Fi settings.

FIND IT

- 
Swipe down for access
- 
SETTINGS
- 
ADVANCED SETTINGS
- 
ENTER CODE (1111, 2222)
- 
SYSTEM TESTS
- 
WI-FI TEST

SENSOR TEST



Sensor Test

Shows actual dBm signal strength of each sensor and graphs sensor events against the ambient noise floor of the environment. Also displays the traditional packet count method.

ZONE	NAME	AVERAGE DBM	LAST EVENT RESULTS (DBM) (PACKETS)		
1	Back Window	Strong (-43)	Strong (-47)	Perfect (16)	
2	Front Window	Strong (-31)	Strong (-33)	Perfect (8)	
3	Back Door	Good (-55)	Good (-55)	Excellent (7)	

The Advanced Sensor Test shows a summary page of each sensor paired to the panel along with the average dBm level, the last event's dBm level and how many packets were received from the sensor.

Select the graph icon to the right of each sensor to view an individual sensor's graphed signal strength in real time.

FIND IT

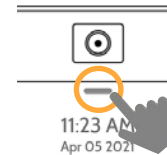

Swipe down for access

- SETTINGS
- ADVANCED SETTINGS
- ENTER CODE (1111, 2222)
- SYSTEM TESTS
- SENSOR TEST

NOTE: For UL/cUL, perform a placement test first for all wireless initiating devices. The acceptable result shall be "Good".

SENSOR TEST



Noise Floor

From the Sensor Test page select the “Settings” cog to view the “Real Time Noise Floor”. The noise floor represents the dBm threshold at which the panel can no longer sense signals from sensors.

ZONE	NAME	AVERAGE DBM	LATEST RESULTS (DBM) (PACKETS)	Settings
1	Versa	Strong (-58)	Strong (-61)	Clear All Sensor Data Real Time Noise Floor
2	Flow	Strong (-62)	Strong (-67)	
4	Front Door	Strong (-51)	Strong (-59)	

Lower dBm levels mean there is less noise or interference on the sensor’s specific operating band or frequency.

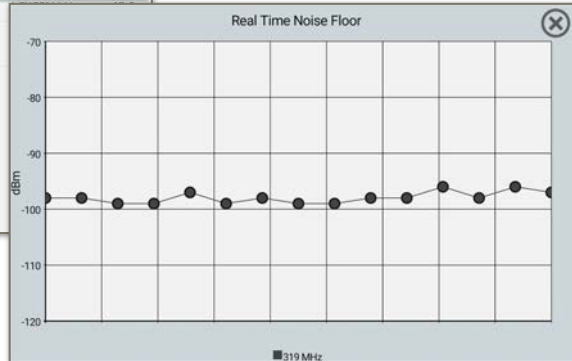

FIND IT

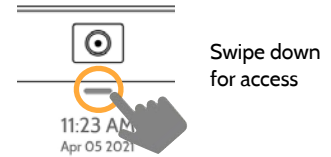

- SETTINGS
- ADVANCED SETTINGS
- ENTER CODE (1111, 2222)
- SYSTEM TESTS
- SENSOR TEST

NOTE: Manufacturer recommended signal to noise ratio is min 7dB

SENSOR TEST

- Colored points on the graph represent each state change or supervisory signal transmitted from a sensor to the panel. Points are colored based on frequency.
- The **YELLOW** line represents a dBm level where signal strength is “Poor” and potential RF failures could occur. This line dynamically adjusts to 12 dBm above the ambient RF noise floor in the environment.
- The **RED** line represents a dBm level where signal strength is “Critical” and RF failures are likely. This line dynamically adjusts to 6 dBm above the ambient RF noise floor in the environment.

TROUBLESHOOTING:

If a sensor falls below the yellow line, try changing its orientation (vertical/horizontal), move the sensor to a different part of the door/window or adjust the panel location.

Then re-test to see if the result improved.



FIND IT

Swipe down for access

11:23 AM
Apr 05 2021

SETTINGS

ADVANCED SETTINGS

ENTER CODE (1111, 2222)

SYSTEM TESTS

SENSOR TEST

NOTE: Manufacturer recommended signal to noise ratio is min 10dB

CELLULAR TEST



Cellular Test

Test the panel's built-in cellular radio connection. You must first activate the radio through Alarm.com prior to running this test. Cell signal strength is only available after the test has been ran successfully.

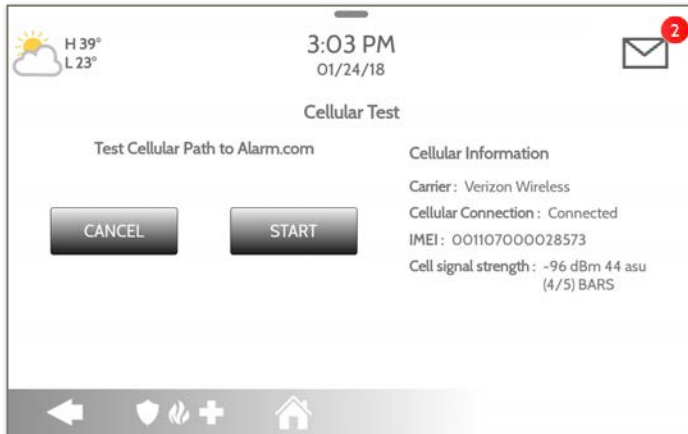

To begin the test press "Start" and watch for the results on the screen.

FIND IT

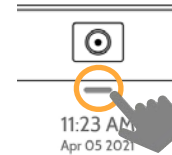

Swipe down for access



SETTINGS



ADVANCED SETTINGS



ENTER CODE (1111, 2222)



SYSTEM TESTS



CELLULAR TEST

Z-WAVE TESTS



Z-Wave Test

Test the connection between the panel and enrolled Z-Wave devices to ensure they are communicating properly.

To perform a Z-Wave Test, touch the “Run” button. A successful test will result in a “Pass” and a time stamp.

ID	TYPE	STATUS	TEST TIME	RESULT
2	Light	Normal		Run
3	Light	Normal		Run
4	Door Lock	Unreachable		Run

NOTE: If a test fails, relocate device, change batteries and/or rediscover network.

FIND IT

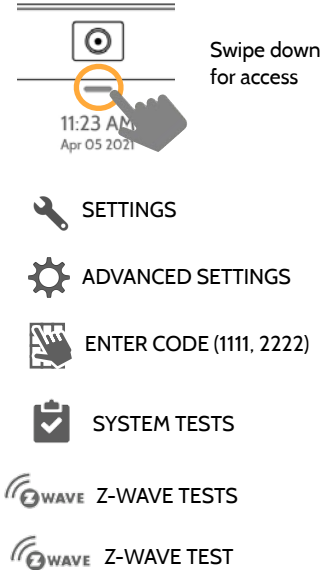

Z-WAVE TESTS



Rediscover Network

After installing or moving a Z-Wave device one should always “Rediscover the Network”. This re-maps the network and ensures all devices have the most efficient communication path leading back to the panel.

Select a single device or all and then select “Rediscover”. A result including a time stamp will appear under “Status”.



NOTE: If a test fails, relocate device, change batteries and/or rediscover network.

FIND IT

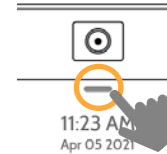

Swipe down for access



SETTINGS



ADVANCED SETTINGS



ENTER CODE (1111, 2222)



SYSTEM TESTS



Z-WAVE Z-WAVE TESTS



REDISCOVER NETWORK

Z-WAVE TESTS



Neighbor Info

Use “Neighbor Info” to view which devices can “see” each other. The more neighbors a device can see means more possible routes back to the controller.

ID	NAME	NEIGHBOR INFO
2	Light	View
3	Bedroom Light	View
4	Front Door	
5	Thermostat	

Neighbor Nodes for Light (5)
4 : front_door

CLOSE

Touch “View” next to any device and a pop-up will appear listing its “Neighbor Nodes”

FIND IT

- Swipe down for access
- 11:23 AM Apr 05 2021
- SETTINGS
- ADVANCED SETTINGS
- ENTER CODE (1111, 2222)
- SYSTEM TESTS
- Z-WAVE Z-WAVE TESTS
- NEIGHBOR INFO

Z-WAVE TESTS



Counters

View a numerical representation of the Z-Wave network. View failed and acknowledged commands as a whole or from an individual device. A well designed network should have at least a 98% acknowledgment vs failed rate.

The screenshot shows two overlapping screens from the mobile app. The background screen displays a list of command statistics:

- Acked commands no auto route : 0
- Acked commands auto route : 5434
- Failed commands no ack : 1
- Failed commands network failed : 0
- Failed commands network not idle : 0
- Failed commands network no route : 0

A "RESET ALL" button is visible at the bottom of this screen. The foreground screen shows a table of device statistics:

ID	NAME	PASSED	FAILED	RESET COUNTERS
3	Light	2921	0	Reset
4	IO Outlet	2521	1	Reset

FIND IT

- Swipe down for access
- SETTINGS
- ADVANCED SETTINGS
- ENTER CODE (1111, 2222)
- SYSTEM TESTS
- Z-WAVE Z-WAVE TESTS
- COUNTERS

Z-WAVE TESTS

COUNTER	DESCRIPTION
Acked commands no auto route	Command was successful and acknowledged by the sensor; it did not use the normal automatic Z-Wave network route to execute the command for this device (command was re-routed on the Z-Wave network in order to succeed)
Acked commands auto route	Command was successful and acknowledged by the sensor; it used the normal automatic Z-Wave network route to execute the command for this device.
Failed commands network failed	Not possible to transmit data because Z-Wave network is busy (jammed). Command failed to execute.
Network failed	Not possible to transmit data because Z-Wave network is busy (jammed). Command failed to execute
Network not idle	Auto-routed command failed because Z-Wave network is not yet stable. Command failed to execute.
Network no route	Auto-routed command failed because there is no successful Z-Wave network route to the device. Command failed to execute
Reset All	Resets all counters back to 0 as to better diagnose the network
Details	Shows individual device details such as passed and failed commands. Here you can also reset an individual device's counter

Z-WAVE TESTS



Z-Wave Diagnostics

View a graphical representation of the installed Z-Wave network. View the network's or an individual device's last known working route. Use the Key chart to decipher which devices are repeating nodes, have a strong or weaker signal or perhaps need to be moved to another location.

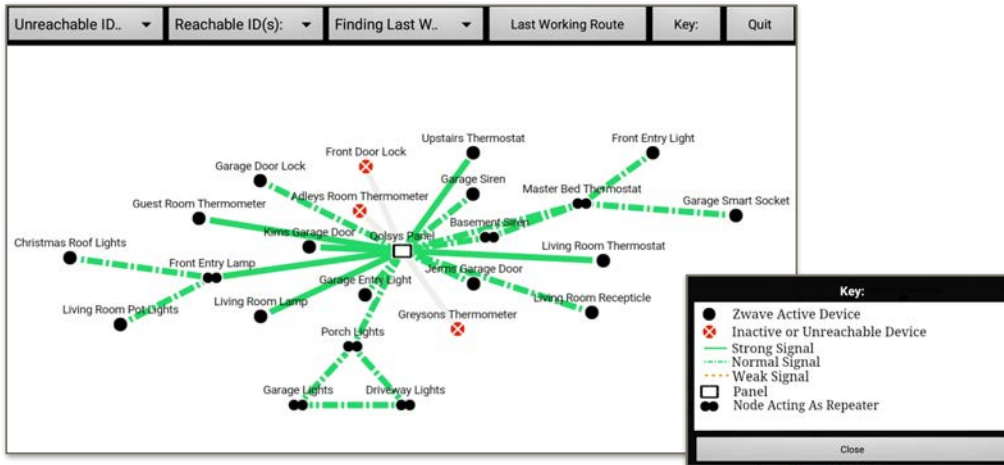

FIND IT

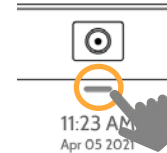

Swipe down for access

11:23 AM
Apr 05 2021



SETTINGS



ADVANCED SETTINGS



ENTER CODE (1111, 2222)



SYSTEM TESTS



Z-WAVE Z-WAVE TESTS



Z-WAVE DIAGNOSTICS

Z-WAVE TESTS



Advanced Z-Wave Diagnostics

Advanced Z-Wave diagnostics gives access to Network Health Test, Repeater Test & Last Working Route.

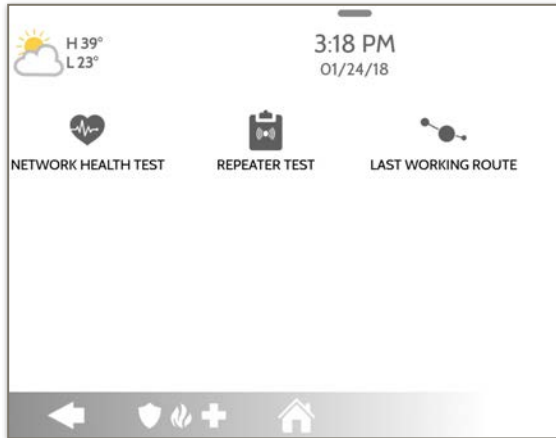

Network Health Test

Shows the minimum, maximum & average node response times on the network



Repeater Test

Tests the connection to dedicated Z-Wave repeaters on the network



Last Working Route

Shows the last working route for a specific node on the network. Also allows you to set a static “sticky” route

FIND IT

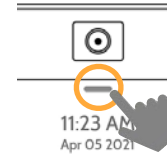

Swipe down for access



SETTINGS



ADVANCED SETTINGS



ENTER CODE (1111, 2222)



SYSTEM TESTS



Z-WAVE TESTS



ADVANCED Z-WAVE DIAGNOSTICS

POWER G TEST



PowerG Test

Ping a PowerG sensor and receive back its signal strength. You can view the average signal strength over 24hrs as well as review the PowerG PIR CAM image.

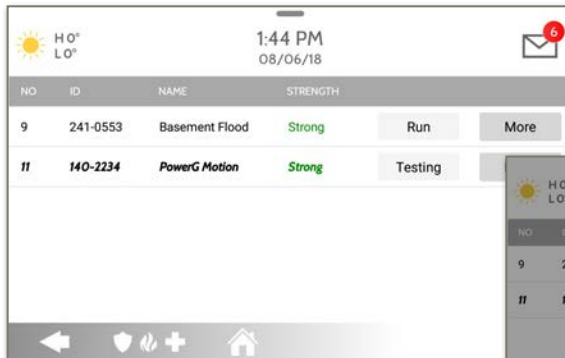

STRENGTH can be: Strong, Good, Poor or No Signal

Note: for UL/cUL and EN Grade 2 installations the signal strength shall be "Strong"

FIND IT

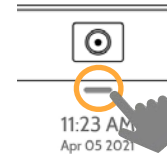

Swipe down for access



SETTINGS



ADVANCED SETTINGS



ENTER CODE (1111, 2222)



SYSTEM TESTS



POWERG TEST

*PowerG daughter card must be installed in the panel to access this test.

POWER G SIGNAL STRENGTH



PowerG Signal Strength

This version of the PowerG test allows the Panel to show the actual dBm signal strength from a PowerG sensor vs the traditional Strong, Good, Poor measurement. It also tracks the signal strength over time and graphs it against the ambient noise floor.

ZONE	NAME	AVERAGE DBM	LATEST DBM	
1	Front Door	Strong (-34)	Strong (-36)	
2	Back Door	Strong (-53)	Strong (-63)	



Strong, Good, Poor or No Signal

Note: for UL/cUL and EN Grade 2 installations the signal strength shall be "Strong"

FIND IT

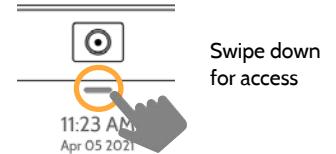

- SETTINGS
- ADVANCED SETTINGS
- ENTER CODE (1111, 2222)
- SYSTEM TESTS
- POWERG TEST

*PowerG daughter card must be installed in the panel to access this test.

ZIGBEE TEST



Zigbee Test

See the last signal strength, average signal strength and battery voltage on Zigbee sensors.

NAME	LAST SIGNAL STRENGTH	AVERAGE SIGNAL STRENGTH	BATTERY
Zigbee Test	Strong (-30 dBm)	Strong (-52 dBm)	2.7 V

STRENGTH can be:

-Strong

-Good

-Poor

-No Signal

FIND IT

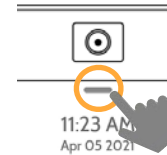

Swipe down for access



SETTINGS



ADVANCED SETTINGS



ENTER CODE (1111, 2222)



SYSTEM TESTS



ZIGBEE TEST

* Requires a Zigbee daughter card be installed in order for this icon to appear. For UL/ULC residential fire and burglary applications the signal strength shall be Strong.

PANEL GLASS BREAK TEST



Panel Glass Break Test

Test the panel's microphones via a clap test or glass break test. This will ensure the built in detector and microphones are functioning properly when needed. Panel Glass Break must be enabled under Installer Settings to access this test.

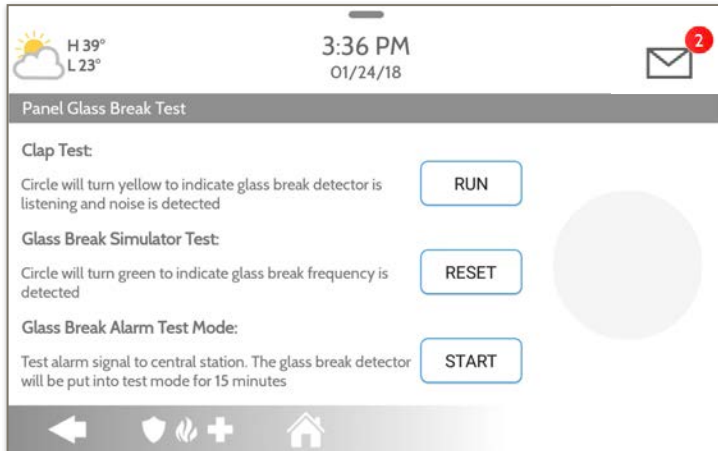

Testing



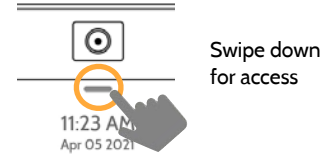

Select "Run" to begin test. Circle will turn **YELLOW** when a successful clap test has been detected and Microphones are listening.

Circle will turn **GREEN** when the panel hears the proper glass break frequency being detected.

FIND IT



Swipe down for access

-  SETTINGS
-  ADVANCED SETTINGS
-  ENTER CODE (1111, 2222)
-  SYSTEM TESTS
-  PANEL GLASS BREAK TEST

PANEL GLASS BREAK TEST



Glass Break Alarm Test Mode

Selecting “Start” will enable a 15 min test mode that allows the panel glass break detector to be tripped using a glass break simulator. Once tripped an alarm will be sent to the central station. Follow the on screen instructions to ensure a proper test.

RUN

RESET

START

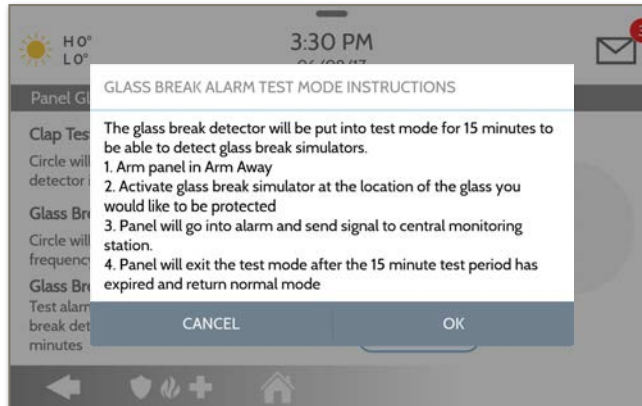

FIND IT

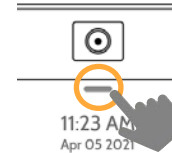

Swipe down for access



SETTINGS



ADVANCED SETTINGS



ENTER CODE (1111, 2222)



SYSTEM TESTS



PANEL GLASS BREAK TEST

PANEL GLASS BREAK DETECTION REQUIREMENTS

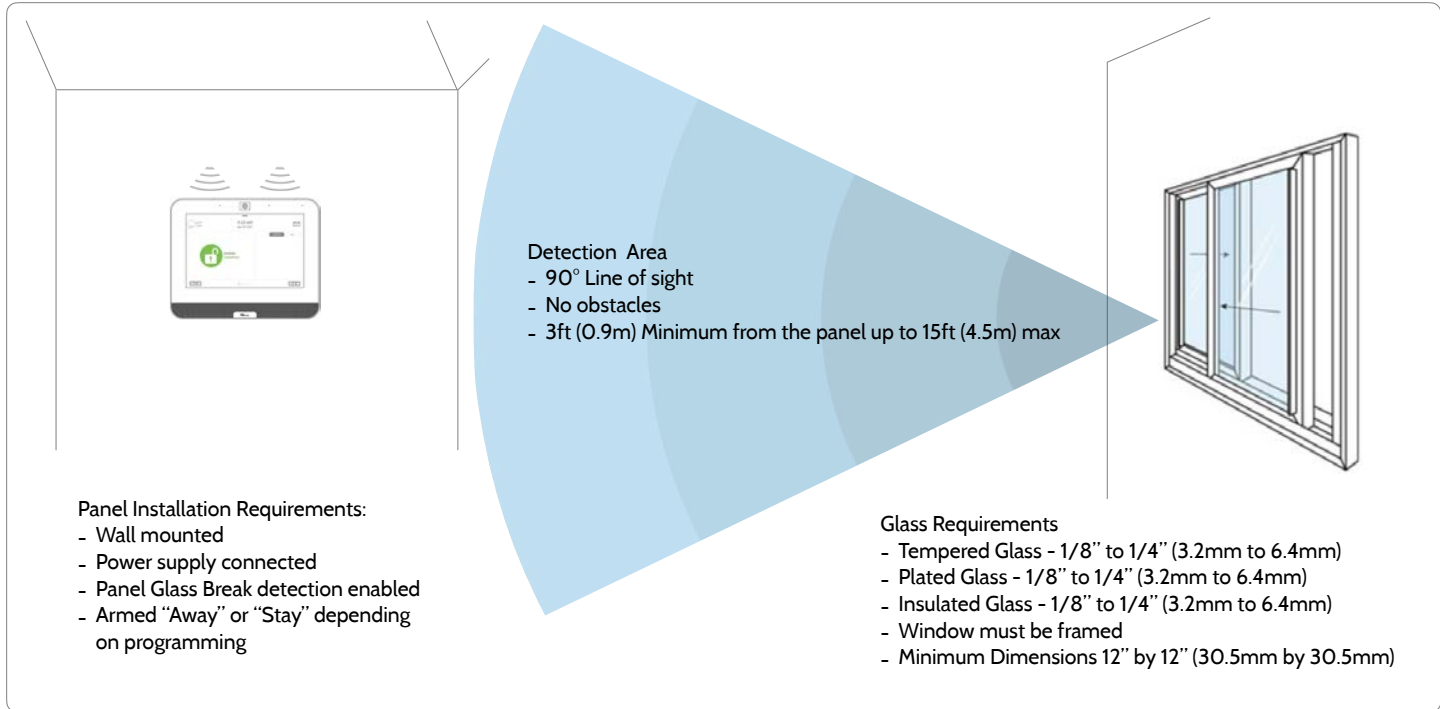

DUAL PATH TEST



When enabled, dual path connectivity allows the IQ Panel 4 to use both cellular and Wi-Fi radios for signals and communication simultaneously.

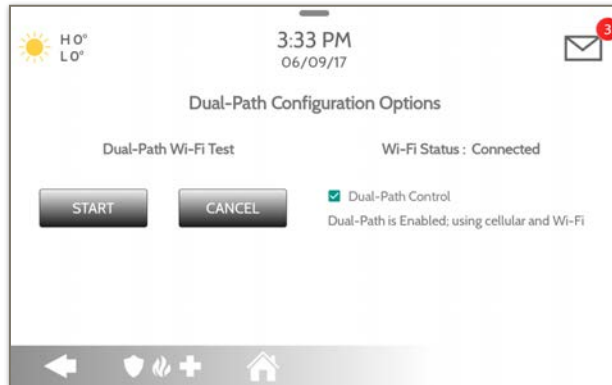

By default Dual-Path Control is enabled. To disable, “un-check” the box.

You can also run a Dual-Path Wi-Fi test to ensure that the Dual Path is connecting properly. Unlike the standard Wi-Fi test (which checks connection to the router) the panel will check the broadband connection to Alarm.com.

NOTE: The IQ Panel 4 must be connected to a Wi-Fi network to enable Dual Path

NOTE: IQ Panel 4 is compatible with the following UL/ULC listed monitoring station receivers: SG-System I/II/III/IV/5. Wi-Fi is for supplemental use only for UL/cUL

FIND IT

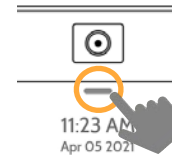

Swipe down for access



SETTINGS



ADVANCED SETTINGS



ENTER CODE (1111, 2222)



SYSTEM TESTS



DUAL PATH TEST

DAUGHTER CARDS TEST



Daughter Cards Test

Tests the integrity of installed daughter cards . Slots not populated will be “greyed” out and inaccessible to test.

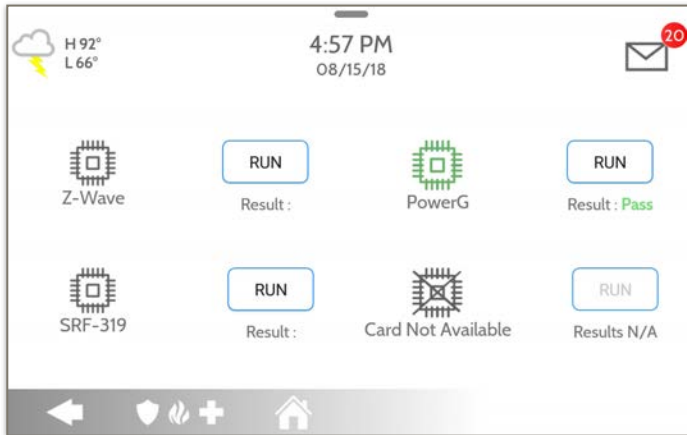

Select “Run” on an individual available card to start the test. In some cases the test may take several minutes after which the panel will show a result of a “Pass” or “Fail”.

If the test results in “Fail” double check the daughter card connection, reboot the panel and rerun the test again.

FIND IT

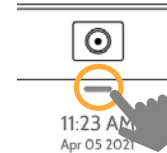

Swipe down for access



SETTINGS



ADVANCED SETTINGS



ENTER CODE (1111, 2222)



SYSTEM TESTS



DAUGHTER CARDS TEST

PANEL TEST



Panel Test

Runs through and tests all panel processes either all at once or one at a time.

TEST NAME	TEST RESULT	TEST TIME	
Arm-Disarm	Pass	01:11 PM, Sep 28, 2016	RUN
Camera	Pass	01:09 PM, Sep 28, 2016	RUN
Photos	Fail	01:11 PM, Sep 28, 2016	RUN
Help Videos	Pass	01:09 PM, Sep 28, 2016	RUN

Buttons: RUN ALL, CLEAR ALL

Select “Run” to perform an individual test or “Run All” to perform a test of all processes.

Running all tests at once will sound the siren.

Note: The Siren can be tested alone under the Panel Test menu, scroll down and select RUN

FIND IT

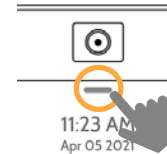

Swipe down for access



SETTINGS



ADVANCED SETTINGS



ENTER CODE (1111, 2222)



SYSTEM TESTS



PANEL TEST

AMBIENT NOISE TEST



Ambient Noise Test

Run a test to better understand the noise in the environment and whether or not the Panel Ambient Noise Detector is likely to trip in a given situation.

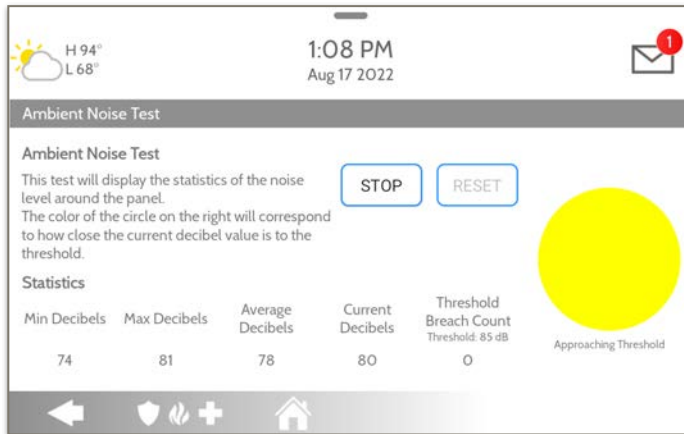

Select “Start” to perform a test of the Panel Ambient Noise Detector. You can Stop, Resume or Reset the test at anytime.

Note: This test can only be accessed if the Panel Ambient Noise Detector Setting is Enabled.

FIND IT

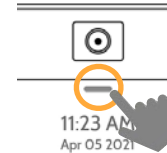

Swipe down for access



SETTINGS



ADVANCED SETTINGS



ENTER CODE (1111, 2222)



SYSTEM TESTS



AMBIENT NOISE TEST

INPUT VOLTAGE TEST



Input Voltage Test

Measure the voltage received at the Panel in real-time.



Press “Start” to run a real-time voltage test on the Panel. If voltage received is above 6vDC, you will get a “Voltage is Good” message.

Note: Test results may vary each time you run the test based on current draw of the panel at that time.

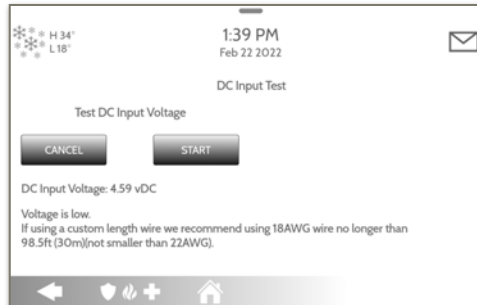

If voltage is below 6vDC, you will receive a “Voltage is Low” message and action should be taken to correct the low voltage condition (i.e. use thicker gauge wire or shorten the wire run).

Note: Wire run length and gauge should not exceed UL specification.

FIND IT

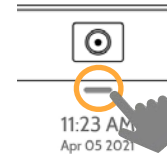

Swipe down
for access



SETTINGS



ADVANCED SETTINGS



ENTER CODE (1111, 2222)



SYSTEM TESTS



INPUT VOLTAGE TEST

CUSTOMIZATION

USER MANAGEMENT



The IQ Panel 4 can hold up to 242 user codes. Only Dealer, Installer and Master user codes can create or edit user codes. Once a code is created, all information can be edited, except for the “User Type”.

User Type	Access Level	Partition Access
Dealer	All settings as well as Master Reset and access to change Dealer Contact information	All Partitions
Installer	All Settings	All Partitions
Master	All user-related features and Settings, including connecting to Wi-Fi, User Management, Sound App and Sensor customization	All Partitions
User	Arming/Disarming	A user may only access their assigned partition
Guest	Arming/Disarming	A user may only access their assigned partition
Duress	Disarming (but sends duress signal to security provider).	Each partition gets a unique Duress Code

FIND IT

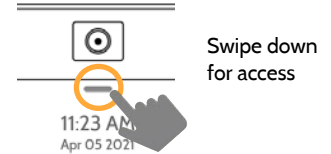

Swipe down for access



SETTINGS



ADVANCED SETTINGS



ENTER CODE (1111, 2222)



USER MANAGEMENT

NOTE: When “6 Digit User Code” is ENABLED a “00” will be appended to all existing 4 digit codes

DEALER BRANDING*



Dealer Branding

Here you can customize the Dealer Contact info.



Contact Info

Edit Dealer Name, Email,
Phone #, Zip Code, Website
and Tag lines



On-Screen Branding

Load a Custom Logo, Dealer
Billboard images or add/
replace Help Videos via the
Panel Access Point

FIND IT

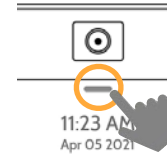

Swipe down
for access



SETTINGS



ADVANCED SETTINGS



ENTER CODE (2222)



DEALER BRANDING

*This page available only through the
Dealer Code

DEALER BRANDING*

FIND IT



Contact Info

Customize your contact info and determine what you'd like to be displayed in "Contact Us", located on the right side of the "Home Screen" header. Dealer Contact fields allow up to 50 characters, Tag Line 2 allows up to 50.

Dealer Name	ABC Security	Email	jondoe@abcsecurity.com
Tag Line 1	Automation & Security	Web	www.ABCsecurity.com
Tag Line 2	Atlanta's Preferred	Installation location ZIP Code	84008
Phone	(798) 123-4567		

SAVE

Example:

ABC Security
Automation & Security
Atlanta's Preferred
798-123-4567
jondoe@abcsecurity.com
ABCSecurity.com
84008

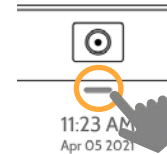

Swipe down for access

- SETTINGS
- ADVANCED SETTINGS
- ENTER CODE (2222)
- DEALER BRANDING
- CONTACT INFO

*This page available only through the Dealer Code

DEALER BRANDING*



On-Screen Branding

Load a Custom Logo, Dealer Billboard images or add/replace Help Videos via the Panel Access Point. Dealer Billboard (photo frame) images cannot be deleted by an end user.



1- Scan the QR Code with your phone camera or manually connect to the Panel AP with the SSID and Password shown on the screen.

2- Press “Start” to begin the local server session, then from your device scan the second QR code or navigate to the “https” site shown on the Panel screen.

3- Follow the prompts on your device screen to select the correct files and transfer them to the Panel.

FIND IT

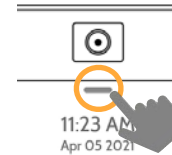

Swipe down
for access



SETTINGS



ADVANCED SETTINGS



ENTER CODE (2222)



DEALER BRANDING



ON-SCREEN BILLBOARD

*This page available only through the
Dealer Code

CONNECTING TO WI-FI



To connect to a Wi-Fi network, follow the steps below:

Swipe down from the top menu bar and select settings.



Touch Advanced Settings (Installer Code)



Then touch "Wi-Fi"



Enable Wi-Fi if not already active

Available networks appear in a list. Touch the desired network and use the keyboard to type the password (if required).

Note: Frequency, PMF and more can be changed under Advanced Settings

Activate WIFI



Qolsys-5G
Connected



Now Communications



Qolsys



Sunset Room



Vertical Ops 2.4

+ Add wi-fi network

FIND IT

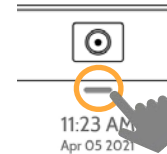

Swipe down for access



SETTINGS



ADVANCED SETTINGS



ENTER CODE (1111, 2222)



WI-FI

WEATHER



H 36° L 20°

TODAY'S FORECAST

Today's forecast is displayed on the weather icon with a graphical representation of precipitation and High and Low temps.

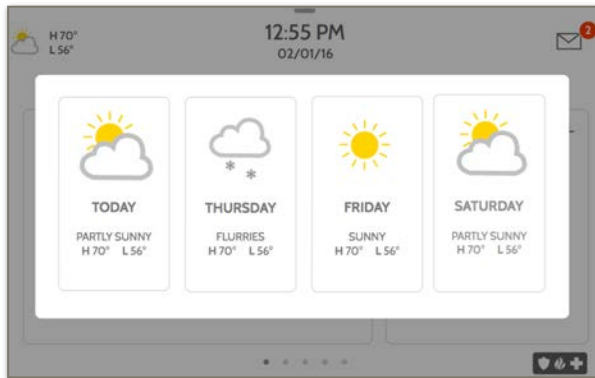

4-DAY FORECAST

Touch the weather icon to get a 4-day forecast. This information is updated once daily via Alarm.com services. (Will not display or update weather connected to wifi only)

LOCATION

Weather reporting is based on location as indicated by the zip code entered into Alarm.com when the account is created.

FIND IT



Touch the weather icon in the upper left corner of the header to reveal a 4 day forecast

PHOTO FRAME



PHOTO FRAME

The IQ Panel 4 can be set to display digital photos when not in use. This feature, called “Photo Frame”, can be changed or turned off through “Photo Frame Settings”. (Swipe down from the menu bar).

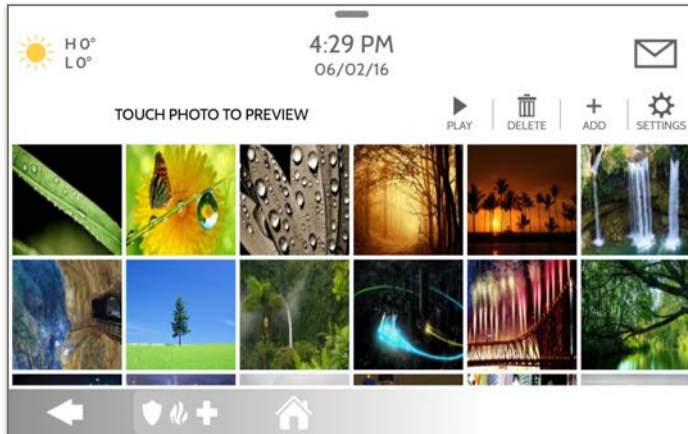

Display type
Choose a display type for your photo frame. Opt to turn it off completely, scroll through pre loaded images or view a “weather clock”

FIND IT

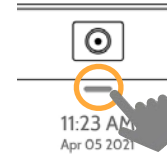

Swipe down
for access



PHOTO FRAME

PHOTO FRAME APP BUTTONS



PLAY: Starts Photo Frame immediately. Good for testing photo frame feature appearance and transitions



REMOVE PHOTOS: Allows you to remove photos one by one or all at once



ADD PHOTOS: Download one of several “Wi-Fi” photo sets using your panel’s WiFi connection. If you are using an Android device, you can transfer photos to the IQ Panel using Bluetooth. You can also transfer photos via the built-in Panel Access Point.



SETTINGS: Change the Photo Frame’s “Display Type” from Off to On or enable a “Weather Clock” screen saver. Change transitions, adjust display time, set automatic on/off times and more

FIND IT

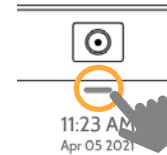

Swipe down
for access

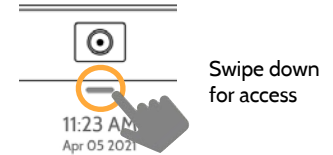

PHOTO FRAME

PHOTO FRAME SETTINGS

FIND IT

Item	Default	Description
Duration	1 minute	How long each image will show before transitioning to the next image in the library (1, 2, or 5 minutes)
Effect	Dissolve	Transition effect used between each image (fade to black, dissolve)
Shuffle	Enabled	Display pictures in random or sequential order
Display Type	Photo Frame	Choose what to display on the screen when the panel is not in use. (Off, Photo Frame and Weather Clock)
Photo Frame Start Time	10 minutes	Choose the amount of time to wait after the last touch before starting the selected display type. (1, 5, 10, 15, 20, 25, or 30 minutes)
Nighttime Mode Start Time	11:00 PM	Determines the time when the display, voices or chimes shutdown completely. (Use this feature to turn off the LCD, voices and/or chimes at night)
Nighttime Mode End Time	6:00 AM	Determines the time when the display, voices or chimes "wake up" after sleeping. (Use this feature to turn the LCD, voices and/or chimes back on in the morning)
Nighttime Mode Settings	Display	Choose what the Nighttime Mode Start/End times have the ability to control (Display, Voices and/or Chimes)



MAINTENANCE

UPGRADE SOFTWARE



Upgrade Software

Upgrade the panel's software version using Wi-Fi.

Setting	Description
Upgrade Using Network	Search the network for updates and install new software NOTE: For UL/cUL or EN Grade 2 installations remote software uploading is not allowed
Upgrade Using Access Point	Connect to the Panels' built-in Access Point to install new software
Patch Tag	A code corresponding to a specific software update on the server
Automatic Background Check and Download	Allows the panel to check for new software in the background and download it to local storage so that it can be applied at a later date. Default Enabled
Automatic Check Interval	Determines interval the IQ Panel 4 will look for software update. Available options are Every Night, Once a Week, Once a Month. Default Once a Week

FIND IT

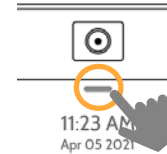

Swipe down for access



SETTINGS



ADVANCED SETTINGS



ENTER CODE (1111, 2222)



UPGRADE SOFTWARE

NOTE: Proper maintenance requires prompt administration of any software updates

UPGRADE SOFTWARE USING WI-FI

Keeping your panel up to date is essential in ensuring it receives the newest features and is free from bugs.

To perform a software update using Wi-Fi follow the steps below:

- 1- Ensure your panel is connected to Wi-Fi and has an internet connection.
- 2- From the drop down menu select "Settings" then "Advanced Settings". (Installer/Dealer Code)
- 3- Touch "Upgrade Software"
- 4- Touch "Upgrade Using Network" The IQ Panel 4 will check for the latest software update. If your panel is up to date you will see a message confirming that you have the most recent software version.
- 5- If a software update IS available the panel will automatically begin downloading it.
- 6- Once the download is complete a pop up message will appear informing you that in order to install the software you must restart the panel. Touch "OK." Your panel will install the update and automatically restart.

FIND IT

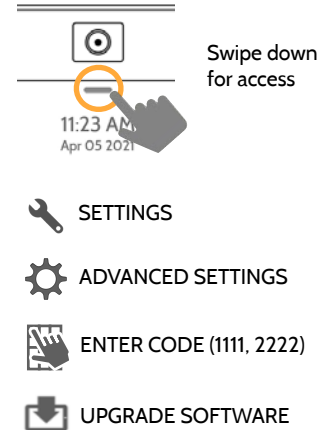

NOTE: For UL/cUL or EN Grade 2 installations the remote software feature shall not be used and the panel shall not be setup to remotely upgrade.

UPGRADE SOFTWARE USING ACCESS POINT

Most updates are downloaded over Wi-Fi, but in the event that Wi-Fi is not present at the installation site, a Panel can be updated with files transferred from a local device (phone, tablet, computer, etc) via the built-in Panel Access Point.

To perform a software update using the Panel Access Point follow the steps below:

- 1- Download the needed software update files from the Dealer Portal to your device (phone, tablet, computer).
- 2- Go to Settings/Advanced Settings/Upgrade Software then touch “Upgrade Using Access Point”.
- 3- Scan the QR Code with your phone camera or manually connect to the Panel AP with the SSID and Password shown on the screen.
- 4- Press “Start” to begin the local server session, then from your device scan the second QR code or navigate to the “https” site shown on the Panel screen.
- 5- Follow the prompts on your device screen to select the correct files and transfer them to the Panel.

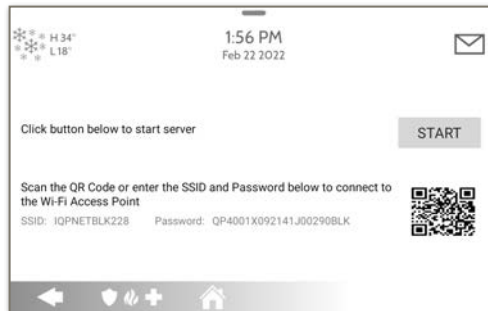

FIND IT

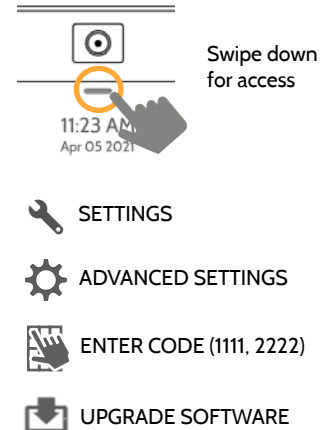

NOTE: For UL/cUL or EN Grade 2 installations the remote software feature shall not be used and the panel shall not be setup to remotely upgrade.

AUTOMATIC BACKGROUND CHECK AND DOWNLOAD

Turning on Automatic Background Check & Download enables the panel to check for a new software version based on the Automatic Check Interval (default is Once a Week).

From the drop down menu select "Settings"

"Advanced Settings": (Installer/Dealer Code)

Touch "Upgrade Software"

Make sure the "Automatic Background Check and Download" button is checked.

Change update interval by selecting "Automatic Check Interval"



QUESTIONS? Contact us at techsupport@qolsys.com

FIND IT

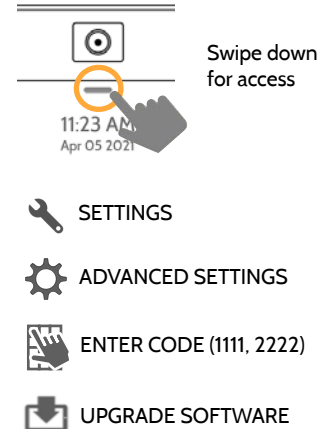

BATTERY REPLACEMENT

NOTE: This device and Lithium Battery shall be recycled and disposed of in accordance with your country (i.e. US, Canada, etc) and Laws including UK and European Directives and any other National and Local Regulations and Laws

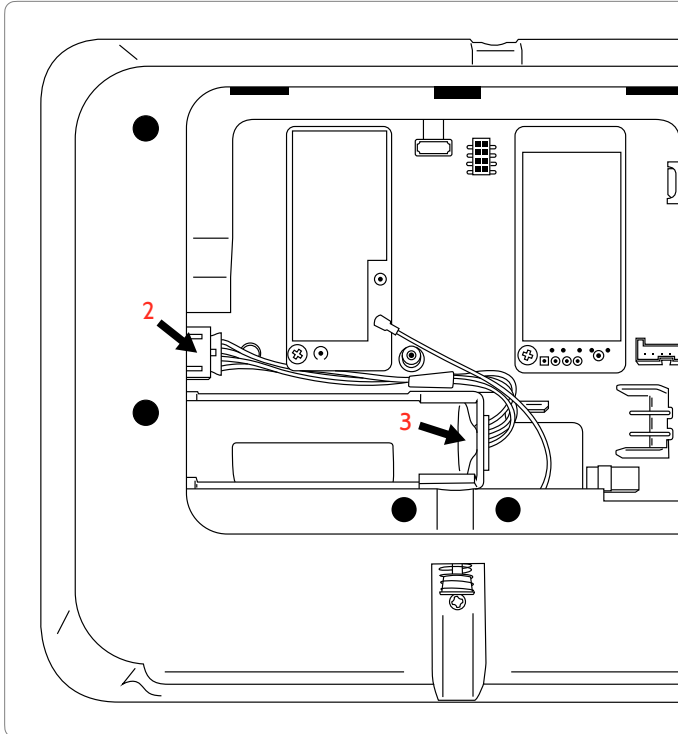

1. **Power down panel:** Go to Settings/Advanced Settings and enter the Installer/Dealer/Master code, then select “Power Down”
2. **Unplug Battery Connector:** Once the panel is powered down, unplug 4 pin battery connector from the board.
3. **Remove Battery:** Pull up on the edge of the battery with your finger to release it from the plastic hold down.
4. **Install New Battery:** Press the battery into place. Route the cable between the battery and the daughter cards. Plug the 4 pin connector back in and power the panel back up.

CAUTION:

Do **NOT** use a screwdriver or anything sharp that could puncture the battery.

Do **NOT** pull on the battery cable to try and remove battery.

BATTERY REPLACEMENT

WARNING: The battery used in this device may present a risk of fire or chemical burn if mistreated. Do not disassemble, heat above 60°C, or incinerate. Replace battery with Icon Energy Systems (Shenzhen) Co Ltd, Model IANO34NA or Ningbo Veken Battery Co. Ltd., Model VT27 only. Use of another battery may present a risk of fire or explosion.

WARNING: Dispose of used battery promptly. Keep away from children. Do not disassemble, do not crush and do not expose of in Fire. Do not leave battery in extremely low air pressure.

TROUBLESHOOTING

ABOUT

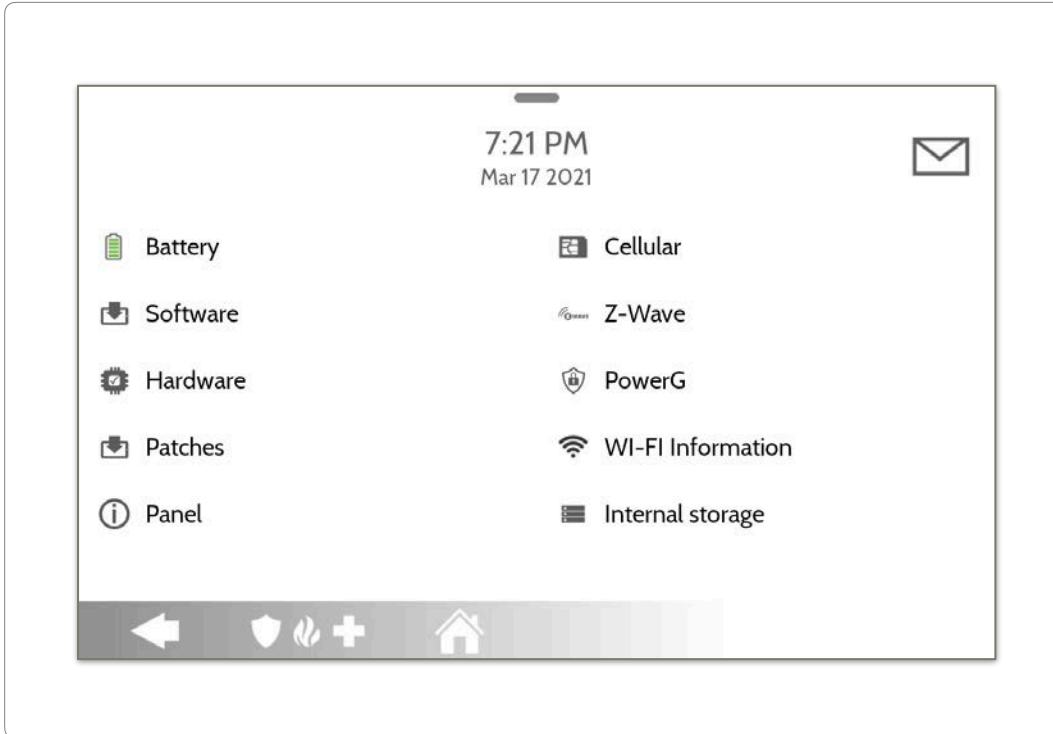

FIND IT

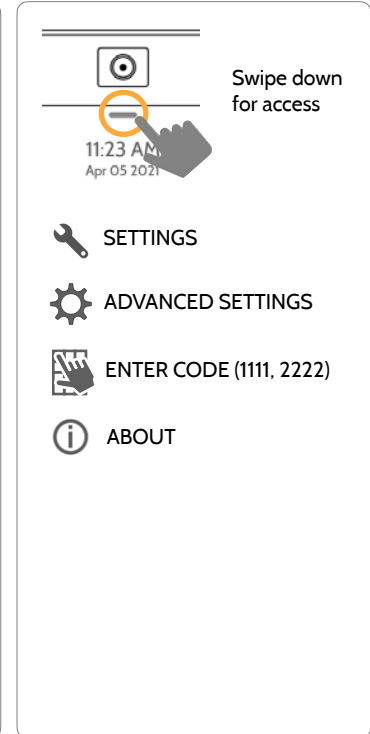

ABOUT

Item	Description	
Battery	Battery Status: Disconnected, Charging, Full	Battery Level: Displayed in %
Software	Software Version: Current Software Version Build Number:	Linux Version: Android Version:
Hardware	Hardware Version: Manufacturer: Qolsys Inc. San Jose, CA PCA Serial #: Part #: System Configuration:	System Serial #: RF PIC Version: EEPROM Format Version:
Patches	Patch Description: Details of all previous patches applied	Last Upgrade Date:
Panel	MAC Address:	Panel Up Time:
Cellular	Carrier: Current Carrier Cellular Connection: no signal, registered etc. Cellular Signal Strength: x/5 bars, (xx/xx) internal IMEI: Alarm.com radio number	IMSI: Carrier Sim Information ICCID: Carrier Sim Information Baseband Version: Configuration Version:

ABOUT

Item	Description	
Z-Wave	Home ID: Z-Wave Firmware Version: Z-Wave API Version:	Manufacturing ID: Product Type: Product ID:
PowerG	Modem Firmware Version Modem Build Number Radio Firmware Version	Radio Software ID PowerG RF Band
Wi-Fi Information	Connection: Connected/Disconnected IP Address: Panel's IP Address when connected SSID: Network panel is connected to	Speed: Connection speed shown in Mbps Internet: Can the panel communicate outside the home. Available/Unavailable
Internal Storage	Total Space: Total space shown in GB Available Space: Space available for media Photos: Breakdown of space used for photos	Videos: Breakdown of space used for videos Logs: Space used for storing panel logs
Zigbee	Zigbee Version: Zigbee Card EUI:	Zigbee Build Version:

POWER DOWN

DO NOT remove all power without following the steps below. In the event of needing to move the panel from one location to another it is safe to unplug the power supply while leaving the battery plugged in.

1. From the drop down menu select “Settings”.
2. Select “Advanced Settings” then enter your installer code
3. Select “Power Down”
4. Wait for panel LED to turn off
5. Disconnect the power

IMPORTANT: Failure to perform these steps in the proper sequence may result in data corruption and/or panel failure.



QUESTIONS? Contact us at techsupport@qolsys.com

FIND IT

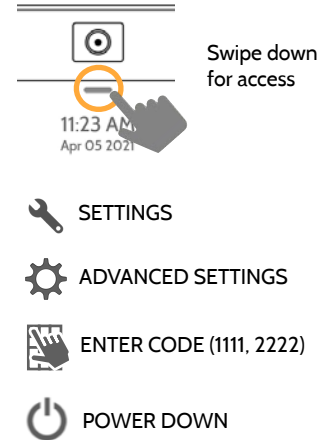

PANEL REBOOT

If the panel is experiencing difficulties you can often resolve it by resetting the operating system.

1. From the drop down menu select “Settings”.
2. Select “Advanced Settings” then enter your installer code
3. Select “Panel Reboot”
4. Wait for the panel to restart

IMPORTANT: Failure to follow these steps properly may result in data corruption and/or panel failure.



QUESTIONS? Contact us at techsupport@qolsys.com

FIND IT

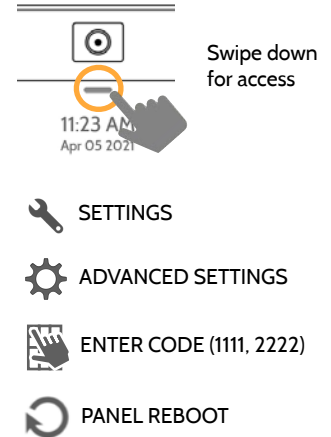

HARD REBOOT

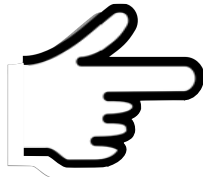

x 30 sec

IMPORTANT: Performing a hard reboot may result in data corruption and/or panel failure. Only use this when absolutely necessary.



QUESTIONS? Contact us at techsupport@qolsys.com

PANEL TEST TROUBLESHOOTING

If you run a panel test and it fails, use the following steps to fix the issue.

Test	Description	If fails:
Arm-Disarm	Tests the arm/disarm operation	Reboot panel, run test again then if necessary perform a master reset and repeat test
Camera	Tests panel camera operation	Reboot panel, run test again then if necessary perform a master reset and repeat test
Photos	Checks that photos are loaded in the photo frame app	1) Go to Settings -> Photo Frame -> Add Photos 2) Add photos from Wifi photo sets
Help Videos	Checks help videos are installed in the panel.	1) Load Help Videos with a Patch Tag
Battery	Checks panel battery health	1) Make sure the battery is connected 2) If test continues to fail, replace the battery
LED Green/Red	Check panel LED operation	1) Reboot the panel and run the test again 2) Master reset and repeat test

PANEL TEST TROUBLESHOOTING

Test	Description	If fails:
Panel Tamper	Check panel Tamper state	<ol style="list-style-type: none"> 1) Check to ensure backplate is secure and installed properly. 2) Repeat test.
AC Status	Check panel AC power status	<ol style="list-style-type: none"> 1) Inspect the wire leads are secure and properly connected on the terminal block and adapter. 2) Repeat test.
Internet Connection	Check panel's Internet connectivity	<ol style="list-style-type: none"> 1) Go to Wifi Setting page. Enable Wifi and connect to a Wifi Network 2) Make sure Internet is available on the home router. You can check internet information in the "About" section. 3) Contact your network service provider on continued internet connectivity failure.
Wi-Fi	Tests whether panel is connected to Wifi network	<ol style="list-style-type: none"> 1) Go to Wifi Setting page and enable wifi. 2) Connect to a Wifi Network
Upgrade Service	Checks that the panel can receive updates from the Qolsys servers	<ol style="list-style-type: none"> 1) Verify internet and Wi-Fi connections.
Z-Wave	Check panel's Z-Wave module operation	<ol style="list-style-type: none"> 1) Reboot the panel and repeat test. 2) Master reset and repeat test
Sirens	Check that the panel's siren is functioning properly (Burglar, Auxiliary, Fire & CO).	<ol style="list-style-type: none"> 1) Verify the siren is plugged in

LEGAL

IMPORTANT

Important warning and information can be found on exterior back of the panel.

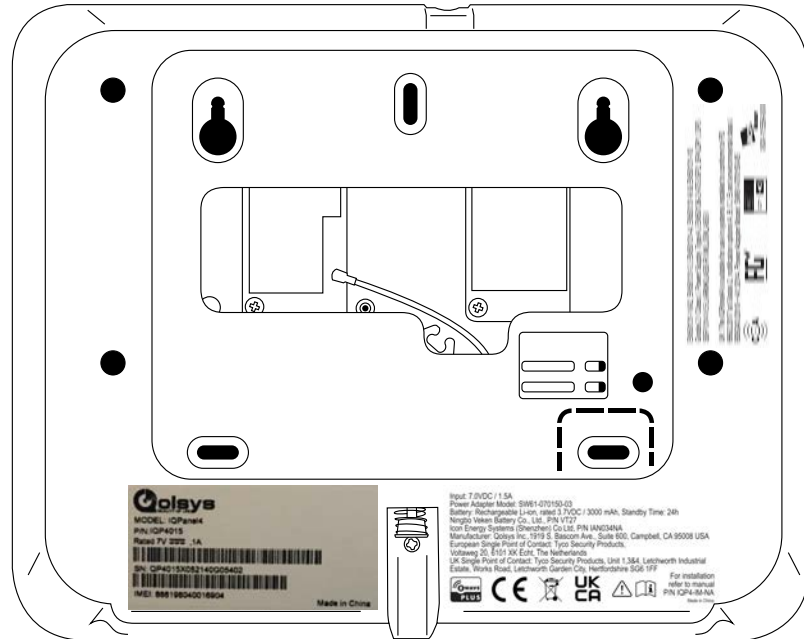

UL/cUL RESIDENTIAL FIRE & BURGLARY INSTALLATIONS

This product has been tested and found in compliance with the following standards: UL1023 Household Burglar-Alarm System Units, UL985 Household Fire Warning System Units, ULC-S545 Residential Fire Warning Systems Control Units and ULC-S304 Security Level I Control Units, Accessories and Receiving Equipment for Intrusion Alarm Systems. For ULC Installations refer to the Standard for the Installation of Residential Fire Warning Systems, CAN/ULC-S540:

- Use only the compatible power supply referenced in this Installation Manual. 24 h standby power must be provided for fire applications and 4h for burglary only applications (AC trouble must be transmitted to SRC within 60 minutes).
- Priority of signals on the Panel is set as Fire, CO, Burg, Panic, Aux and then Flood.
- Use at least one compatible listed Smoke Detector for Fire Installations.
- The entry delay shall not exceed 45 sec (UL) and 180 sec (ULC Security Level 1).
- The exit delay shall not exceed 120 seconds (UL).
- The control panel supports the Temporal 3 pattern for fire alarm notification
- Test transmission cycle shall be set for 7 days transmission for Residential Fire applications, or 30 days for Residential Burglary only applications.
- If Wireless Repeater is required to be employed with a RF Smoke Detectors or CO Detectors, two repeaters must be installed to cover EACH Smoke Detector and/or EACH CO detector.

UL/cUL RESIDENTIAL FIRE & BURGLARY INSTALLATIONS

Note: For ULC Residential Fire and Burglary (ULC-S304 Level I) installations set for daily test transmission, Wireless Supervision window shall be set to 4 hours for UL/ULC Residential Fire Installations. Wireless Supervision window shall be set to 24 hours for Residential Burglary Installations only. RF Jam detection shall be enabled.

For UL 985 6th Ed. Compliant installations using also the Wi-Fi connection, ensure Power for network equipment such as hubs, switches, routers, servers, modems, etc., is backed up or powered by an uninterruptible power supply (UPS), standby battery or the control unit, capable of facilitating 24 h standby

Note: For UL residential fire and burglary applications, it is required to use UL listed compatible siren models PG9901 or PG9911 to provide mandatory local notifications for fire and burglary alarms. The integral sounder is considered for supplementary use only. A maximum of two daughter radio cards (PowerG, SRF319, SRF345, SRF433 [DSC or AT&T], and Zigbee) shall be used in the available slots.

Note: SRF345, SRF433 and SRF433 AT&T cards along with the compatible devices are UL/cUL listed only for use in residential fire and burglary applications (ULC-S304 Security Level I).

UL/ULC COMMERCIAL BURGLARY INSTALLATIONS

This product has been tested and found in compliance with the following standards: UL2610 Central Station Burglar-Alarm Units and ULC-S304 Control Units, Accessories and Receiving Equipment for Intrusion Alarm Systems, Security Levels I-II.

The subscriber control unit shall provide for the connection of protective wiring, conductors, and attachments in accordance with the Standard for Installation and Classification of Burglar and Holdup Alarm Systems, UL 681 in USA and in accordance with ULC-S301, CSA C22.1, Canadian Electrical Code, Part I, Safety Standard for Electrical Installations and ULC-S302 Standard for the Installation, Inspection and Testing of Intrusion Alarm Systems, in Canada.

Note: The product is not intended for installation outdoors or outside the protected premises.

This product is UL/ULC listed under the following categories: AMCE/AMCX7 Central Stations Alarm Units, UTOU/UTOU7 Control Units and Accessories, Household System Type NBSX/NBSX7 Household Burglar Alarm System Units. Zigbee card shall not be installed. For further information on this product's listings please also refer to the official listing guides published at the UL website (www.ul.com) under Online Directory Section.

Programming:

The notes in the Installation Manual describing the system configurations for UL/uLC listed installations shall be implemented. RF Jam detection shall be enabled. Panel Siren is for supplementary use.

Use only PowerG sensors listed in "Supported PowerG Sensors" of this installer manual for UL/ULC Commercial Burglary installations. Require valid user code to arm this system must be enabled.

UL/ULC COMMERCIAL BURGLARY INSTALLATIONS continued...

UL2610 Central Station with Standard or Encrypted Line Security Service and ULC-S304 Security Level I-II/A3 Active communication channel:

- The installation must use the integral cellular communicator, which sends events over Cellular Data Network to the compatible Sur-Gard System I/II/III/IV/5 receiver.
- The communication path supervision window is set to 180s with 90s heartbeat and the compromise detection takes place within 3 minutes. The panel is using encrypted line security AES256. NIST certificate A1554.
- Wireless Supervision window shall be enabled and set to 4 hours
- Open/Closing acknowledgment shall be enabled
- For ULC-S304 compliant installations using also the Wi-Fi connection, ensure Power for network equipment such as hubs, switches, routers, servers, modems, etc., is backed up or powered by an uninterruptible power supply (UPS), standby battery or the control unit, capable of facilitating 24 h standby.
- The entry delay shall not exceed 60s (UL) and 60s (ULC Security Level II).
- The exit delay shall not exceed 60s (UL) and 45s (ULC Security Level II).

Note: For UL certified Commercial Burglary Central Station applications the IQ Panel 4 provides an acknowledgment signal to the user interface to confirm that a normal closing signal has been received once the system has been armed. The device causes an audible and visual indication, when it receives the acknowledgment signal transmitted from the monitoring station compatible receiver: "Panel - Arming Response from Central Station is Acknowledged"

UL/ULC COMMERCIAL BURGLARY INSTALLATIONS continued...

Protection of the Control Unit:

The local control unit and the local power supply must be protected in one of the following ways:

- The control unit and audible alarm device must be in a protected area which is armed 24 hours a day.
- Each partition must arm the area protecting the control unit and the audible alarm device power supply. This may require duplicate protection armed by each partition. Access to this protected area, without causing an alarm, will require that all partitions be disarmed.
- In all cases described above, the protected area for the control unit must be programmed as not-bypassable

For installations employing packet switched (network) communications such as Cellular/Wi-Fi the following recommendations shall be followed:

- Select the Internet Service Providers that have redundant servers/systems and Back-up power.
- Routers shall have Firewalls enabled and methods to identify and protect against “Denial of Service” attacks (i.e. via “spoofing”).
- For UL Commercial Burglary applications the loss of communication with the monitoring station shall be treated as an alarm condition by monitoring station personnel when the burglar alarm system is in the armed state, and as a trouble condition while the system is disarmed. Packet switched data network (PSDN) interface equipment, manufactured by other than the burglar alarm equipment manufacturer, that is not provided with the burglar alarm system and/or not required for the processing of the signals shall be evaluated to the applicable requirements of the Standard for Information Technology Equipment - Safety - Part 1: General Requirements, UL 60950-1, or the Standard for Audio/Video, Information and Communication Technology Equipment - Part 1: Safety Requirements, UL 62368-1, as communication equipment. Any network interface device which adds value or manipulates the original data packet such as changing transmission formats, adding encryption, and the like, shall comply with the applicable requirements noted in this standard.

UL/ULC COMMERCIAL BURGLARY INSTALLATIONS continued...

User Information:

- The installer should advise the user and note in the User's Manual
- Service organization name and telephone number
- The programmed exit and entry time
- Instructions to test system weekly
- Note that the installer code cannot arm or disarm the system
- The installer should caution the user not to give system information (e.g., codes, bypass methods, etc.) to casual users (e.g., service people) and to only give out codes set to expire within 24 hours
- Identification of the conditions that might be expected to result in false alarms or impaired operation of the product(s): arming the system and not respecting the exit delay, entering the protected premises and not respecting the entry delay for disarming the system can cause false alarms.

FCC & ISED CANADA COMPLIANCE STATEMENT

This Class [B] digital apparatus meets all requirements of the Canadian Interference–Causing Equipment Regulations.
Cet appareil numérique de la classe [B] respecte toutes les exigences du Règlement sur le matériel brouilleur du Canada.

IMPORTANT! Changes or modifications not expressly approved by Qolsys Inc. could void the user's authority to operate the equipment.

CAUTION! This equipment complies with radiation exposure limits set forth for uncontrolled environment. The antenna(s) used for these transmitters must be installed to provide a separation distance of at least 27 cm from all persons and must not be collocated or operating in conjunction with any other antenna or transmitter.

This device complies with Part 15 of the FCC Rules. Operation is subject to the following two conditions: (1) this device may not cause harmful interference, and (2) this device must accept any interference received, including interference that may cause undesired operation.

FCC & ISED CANADA COMPLIANCE STATEMENT continued...

This equipment has been tested and found to comply with the limits for a Class B digital device, pursuant to part 15 of the FCC Rules. These limits are designed to provide reasonable protection against harmful interference in a residential installation. This equipment generates, uses and can radiate radio frequency energy and, if not installed and used in accordance with the instructions, may cause harmful interference to radio communications. However, there is no guarantee that interference will not occur in a particular installation. If this equipment does cause harmful interference to radio or television reception, which can be determined by turning the equipment off and on, the user is encouraged to try to correct the interference by one or more of the following measures:

- Reorient or relocate the receiving antenna.
- Increase the separation between the equipment and receiver.
- Connect the equipment into an outlet on a circuit different from that to which the receiver is connected.
- Consult the dealer or an experienced radio/TV technician for help.

FCC & ISED CANADA COMPLIANCE STATEMENT continued...

Déclaration d'exposition aux radiations:

Cet équipement est conforme aux limites d'exposition aux rayonnements IC établies pour un environnement non contrôlé. Cet équipement doit être installé et utilisé avec un minimum de 27 cm de distance entre la source de rayonnement et votre corps.

Le présent appareil est conforme aux CNR d'Industrie Canada applicables aux appareils radio exempts de licence. L'exploitation est autorisée aux deux conditions suivantes:

1. l'appareil ne doit pas produire de brouillage, et
2. l'utilisateur de l'appareil doit accepter tout brouillage radioélectrique subi, même si le brouillage est susceptible d'en compromettre le fonctionnement.
3. Cet appareil numérique de la classe B est conforme à la norme NMB-003 du Canada.

Cet appareil est conforme à la norme RSS-247 d'Industrie Canada. L'opération est soumise à la condition que cet appareil ne provoque aucune interférence nuisible.

Cet appareil et son antenne ne doivent pas être situés ou fonctionner en conjonction avec une autre antenne ou un autre émetteur, exception faites des radios intégrées qui ont été testées.

CE COMPLIANCE STATEMENT

CE DECLARATION OF CONFORMITY

This product is in conformity with the Electromagnetic Compatibility Directive 2014/30/EU, the Low Voltage Directive 2014/35/EU, and the RoHS3 Directive (EU) 2015/863.

The product is labelled with the CE mark as proof of compliance with the above mentioned European Directives. Also, a CE declaration of conformity (DoC) for this product can be found at www.qolsys.com

Simplified EU Declaration of Conformity Hereby, Qolsys Inc. declares that the radio equipment type is in compliance with Directive 2014/53/EU. The full text of the EU declaration of conformity is available at the following internet address: www.qolsys.com

Frequency Bands	Maximum Power	Frequency Bands	Maximum Power
868.0 MHz - 868.6 MHz	15 mW	868.7 MHz - 869.2 MHz	15 mW
Wi-Fi 2402 - 2480.5MHz	2.1 mW	Wi-Fi 2412 - 2462 MHz	219.3 mW
Wi-Fi 5108 - 5240 MHz	66.7 mW	Wi-Fi 5260 - 5320 MHz	67.1 mW
Wi-Fi 5500 - 5700 MHz	69.8 mW	Wi-Fi 5745 - 5825 MHz	66.2 mW
BLE 2402 - 2480 MHz	6.3 mW	UMTS I/LTE B1 2100 MHz	0.25 W
UMTS VIII/LTE B8 900 MHz	0.25 W	LTE B20 700MHz	0.25 W

European single point of contact: Tyco Safety Products, Voltaweg 20,6101 XK Echt, Netherlands.

UK single point of contact: Tyco Security Products, Unit 1, 3 & 4, Letchworth Industrial Estate, Works Road, Letchworth Garden City, Hertfordshire SG6 1FF

EN COMPLIANCE STATEMENT

EUROPEAN EN50131 COMPLIANCE STATEMENT (Only for those products labeled EN50131 Compliant)

This product, IQPanel 4, has been certified by Telefication/Kiwa for installations in accordance with EN50131 up to Grade 2, Class I and meets the requirements of Grade 2, Class I equipment per Standards: EN50131-1:2006+A1:2009+ A2:2017+A3:2020, EN50131-3:2009, EN50131-4: 2019, EN50131-10: 2014, EN50131-6:2017 Type A, EN50136-1:2012, EN50136-2:2013 ATS category SP2, SP4, DP1, DP3.

For EN50131 compliant installations, with alarm control panel IQPanel 4, only the intrusion portion of the alarm system may be activated.

For EN50131 compliant installations, the following functions must be disabled:

- Fire Alarm
- CO Alarm
- Auxiliary (Medical) Alarm functions

The PowerG peripheral devices have two-way communication functionality, providing additional benefits as described in the technical brochure. This functionality has not been tested to comply with the respective technical requirements and should therefore be considered outside the scope of the product's certification.

EN COMPLIANCE STATEMENT continued...

Enable “EN Grade 2” Setting

By enabling “EN Grade 2” setting, the following parameters will be changed automatically.

- Entry Procedure (EU) - Follows entry procedures and alarm transmission delays specified by EN 50131-1 standards section 8.38
- Enables arming protest feature when trouble conditions are present. The user must override any troubles in order to arm the system.
- Trouble conditions will remain present until a user has acknowledged them.
- Trouble beeps are expanded to include fault indications required by EN 50131-1 section 8.5.2
- Screen will automatically lock 30 seconds after disarming the system.
- EU Event history buffer - Found in the basic settings menus, EU Events will record mandatory history events specified by EN 50131-1 section 8.10
- Enables “EU Event Swinger Shutdown Count” - setting to change the count to 3 events allowed for any individual event during an arming cycle
- “Auto Bypass” setting is not available
- Panel allows 5 incorrect user code attempts and then locks access for 90 seconds

The installer must be responsible for settings the rest of the following parameters in order to be EN 50131-1 compliant:

- Enable “Screen Lock” settings
 - Set “Loss of Supervisory Signals for PowerG non-emergency sensors” to 20 minutes
 - Set “Normal Entry Delay” to maximum 45 seconds
 - Set Trouble Beeps Timeout to 3 minutes
 - Enable “PowerG RF Jam” EN 30/60
 - Set “Dialer Delay” must remain at 30 seconds
 - Disable “LED Indicator”
 - Disable “Fire Panic” and “Auxiliary Panic”
 - Enable 6 digit access codes
 - “Voice Prompt” needs to be disabled for the security sensors for EN compliant installations
- User must enable “Dealer or Installer Access Requires User Permission

EN COMPLIANCE STATEMENT continued...

Notes for EN50136-1:2012 Compliant Installations:

The IQ Panel 4 has an integral communicator using the Qolsys proprietary serial interface. The communicator circuitry operates in pass-through mode and it does acknowledge the alarm to the compatible controls panel after an acknowledgement has been received from the compatible alarm receiver.

The IQ Panel 4 integral communicators are compatible with the following receivers: Sur-Gard System I-IP Receiver, version 1.41+. Sur-Gard System II Receiver, version 2.14+, Sur-Gard SG-DRL3-IP, version 2.36+ (for Sur-Gard System III Receiver), Sur-Gard SG-DRL4-IP version 1.29+ (for Sur-Gard System IV Receiver), and Sur-Gard SGDRL5-IP version 1.04+ (for Sur-Gard System 5 Receiver).

1. The IQ Panel 4 integral communicator is monitored by the control panel and it is programmed via the programming menu available from the website portal.
2. The HSPA 3G/LTE Cellular path is immune to conducted and radiated RF fields with levels up to 10V/m as tested per EN50130-4 Standard.
3. The IQ Panel 4 integral communicator conforms with radiated emissions levels for Class B equipment as per standards EN61000-6-3/EN55032/CISPR32.
4. The IQ Panel 4 integral communicator has one cellular communication path using 900/1800/2100 MHz Public Cellular Network and one Wi-Fi 2.4/5GHz communication path. It can use one, the cellular path (SP2 or SP4) or both in backup configuration (DP1 or DP4 using cellular as primary path and Wi-Fi as back-up).
5. The IQ Panel 4 integral communicator used AES128 encryption algorithm for communication with compatible receivers. The AES 128 encryption of data communication ensures substitution and information security.
6. The IQ Panel 4 integral communicator has been tested for compliance in conjunctions with the following applicable standards: EN50136-1:2012+A2:2018, EN50136-2:2013, EN50131-10:2014, ATS configuration: SP2, SP4 and DP1, DP3.

For EN50131-1:2006/A1:2009/A2:2017/A3:2020 compliant installations, the following programming options shall be set as described: Test transmission interval set to 24h for SP2 and DP1 configuration. Supervision shall be set to 180s for SP4 and DP3 configurations. IQ Panel 4 integral communicator has been certified by Telefication in accordance with EN50131-1:2006/A1:2009/A2:2017/A3:2020, EN50131-10:2014 requirements for Grade 2, Class I and EN50136-2:2013 Configuration: SP2, SP4, DP1 and DP3.

UK COMPLIANCE STATEMENT

PD6662 COMPLIANCE STATEMENT (Only for those products used in UK installations)

The IQPanel 4 is suitable for use in systems installed to conform to PD6662:2017 (with notification options: A, B, C, D, or F) at Security Grade 2 and environmental Class I. BS8243:2010 + A1:2014, where Option:

- A. denotes use of 2 remotely powered sirens and single path rated SP2 communicator
- B. denotes use of a self powered siren (ex. PG8901/PG8911) and a single path rated SP2 (24h supervision, use Cell only) communicator
- C. denotes use of a dual path rated DP1 (24h supervision, use Cell and Wi-Fi) communicator, use of sirens is optional
- D. denotes use of single path rated SP4 (180s supervision, use Cell only) communicator, use of sirens is optional
- F. denotes use of a dual path rated DP3 (180s supervision, use Cell and Wi-Fi) communicator, use of sirens is optional

ADDITIONAL LEGAL INSTRUCTIONS

Recycling and Disposal:



Dispose in accordance with applicable legislation. This product must be disposed of separately from general household waste. Take it to a designated waste collection point in your area for safe disposal or recycling in accordance with National (i.e. US, Canada, European, Mexico, etc), Regional, State and Local Regulations and Laws. By doing this, conservation of natural resources, protection of the environment and human health occurs.

SPECIFICATIONS

SPECIFICATIONS - NORTH AMERICA



Items	Parameters	IQ Panel 4
Platform	Android OS	Android 9
LCD Display	Size	7" (17.8CM) LCD
	Resolution	1280 x 800 pixels
	Brightness	300 cd/m ²
	RGB Color	24bit, 16.9 million colors
Processor	8 Core	Qualcomm Snapdragon 8 Core SOM (System On a Module) with 16 GB of NAND Flash
Touchscreen	Type	Capacitive glass multi-touch
User Codes	Up to 242	Role based (Dealer, Installer, Master, User, Guest, Duress)
Network	WiFi	Wi-Fi 802.11 a/b/g/n/ac dual band 2.4/5ghz - including built-in router capability
	Cellular	LTE CAT4 (Bands 2/25, 4/66, 5/26, 7, 12/17, 13, 14 (non-First Net))
Z-Wave Plus 700	Up to 167 Devices	167 total devices (80 lights, 20 Locks, 40 Thermostats, 21 Misc, 6 Garage Doors)
PowerG	Up to 128 devices	915 MHz, long range, secure encrypted two-way wireless
Security RF		Depending on the model; either S-Line encrypted 319.5MHz, 345MHz or 433MHz
Bluetooth	Disarming, Audio Streaming	Qualcomm Bluetooth Low Energy (BLE) 4.2
Flash Memory	Internal Storage	16GB NAND Flash

SPECIFICATIONS - NORTH AMERICA



Items	Parameters	IQ Panel 4
LED Indicator	Status LED	Green (Disarmed), Red (Armed), Triple full color RGB LED
Speakers/Siren	4w x 4	QuadSound 4x Front Facing 4watt speakers and 85dB siren
Camera	Front Camera	8MP wide angle 120° field of view, fixed focus camera with FlexTilt adjustment
Microphone	MEMs x 3	3 MEMs (micro electro mechanical system) Microphones with echo cancellation
Tamper	Tamper Switch	Dual Panel and wall tamper switch with spring release
Battery	Type 18650	Lithium Ion 3000mAh. Ningbo Veken Battery Co., Ltd, Model VT27 or Icon Energy System Co. Ltd, Model IANO34NA
Buttons	Hard Button	Single wake/sleep button used for sleep/wake, hard reboot, and clean screen cancel
Mechanical	Dimension	6.1"H x 7.5"W x 1"D (155mm x 191mm x 26mm)
Power Supply	AC/DC External Plug-in Adapter	Output: 7vDC (=) 1000mA CC, or 7vDC(=) 1.5A CC, Input 100-240VAC 50/60Hz. Adapter evaluated at 120vAC for UL/cUL
Mount	Back Plate	SmartMount wall mount included. SmartMount table stand or SmartMount IQ Base table stand with built-in subwoofer sold separately.
Certification	UL/ULC	UL/ULC Residential Fire and Burglary and UL/ULC Commercial Burglary Alarm Control Unit. Compliant with standards: UL985, UL1023, UL2610, ULC-S545, ULC-S304
	FCC	2AAJXQS-IQP4 (may contain additional modules with separate FCC ID's)
	IC	11205A-QSIQP4 (may contain additional modules with separate IC ID's)
	NOM, IFETEL	Certificado No.: Reserved
Temperature	Operational	0 to 49C, up to 93% relative humidity, indoor, dry ordinary locations use only
	Storage	-20 to 50C

SUPPORTED 319 MHz S-LINE SENSORS



Detector Type	Model
IQ Door/Window-S	QS1133-840 ^{UL} , (UL Listed M/N: 60-362N-10-319.5), QS1135-840, QS1136-840, QS1137-840
IQ Motion-S	QS1230-840 ^{UL} , (UL Listed M/N: 60-639-95R), QS1231-840
IQ Glass-S	QS1431-840 ^{UL} , (UL Listed M/N: IQ Glass-S)
IQ Smoke	QS5110-840 ^{UL}
IQ CO	QS5210-840 ^{UL}
Keyfobs	QS1331-840
Tilt Sensor	QS1131-840
Flood Detector	QS5536-840
Temperature Sensor	QS5535-840
IQ Hardwire 16-F	QS7133-840 ^{UL}

NOTE: ^{UL} indicates that the device is certified to UL standards. These devices are not suitable for UL Commercial Burg applications.

SUPPORTED 345 MHz SENSORS



Detector Type	Model
Door/Window Contact	5816WMWH ^{UL RB (NO ULC)}
Door/Window Contact	5815 ^{UL RB}
Motion Detector	5800PIR-COM ^{UL RB}
Motion Detector	5898 ^{UL RB}
Motion Detector	5800PIR ^{UL RB}
Glass Break Detector	5853 ^{UL RB}
Smoke Detector	5806W3 ^{UL RF (NO ULC)}
Smoke Detector	5808W3 ^{UL RF}
Smoke/CO Detector	5800COMBO ^{UL RF}
CO Detector	5800CO ^{UL RF}
CO Detector	GG-CO8345 (2GIG-CO8-345) ^{UL RF (NO ULC)}

NOTE: Use only UL/ULC listed devices for UL/ULC certified installations.

SUPPORTED 433 MHz (SRF433 DSC) SENSORS



Detector Type	Model
Door/Window Sensor	WS4945NA ^{UL RB}
Motion Detector	WS4904P ^{UL RB}
Motion Detector	WLS914-433 ^{UL RB}
Glass Break Sensor	WLS912L-433 ^{UL RB}
Shock Sensor	EV-DW4927SS ^{UL RB}
Smoke Detector	WS4936 ^{UL RF}
Carbon Monoxide Detector	WS4933 ^{UL RF}
2 Button Key Fob	WS4949 ^{UL RB}
4 Button Key Fob	WS4939 ^{UL RB}
Pendant Button	WS4938 ^{UL RB}
Wireless Repeater	WS4920 ^{UL RF/RB}

NOTE: Use only UL/ULC listed devices for UL/ULC certified installations.

SUPPORTED 433 MHz (SRF433 AT&T Digital Life) SENSORS



Detector Type	Model
Door/Window	SW-ATT-V2 ^{UL}
Recessed Door/Window Contact	SW-ATT-RDW ^{UL}
PIR Motion Detector	SW-ATT-PIR ^{UL}
Glassbreak Detector	SW-ATT-GB ^{UL}
Smoke Detector	SW-ATT-SMKT ^{UL}
Wireless CO Detector	SW-ATT-CO ^{UL}
Keyfobs	SW-ATT-FOB
Repeater/Signal Booster	SW-ATT-RPTR4 ^{UL}
Hardwire Translator	SW-ATT-TAKRF ^{UL}

NOTE: ^{UL} indicates that the device is certified to UL standards. These devices are to be used only for UL residential fire and burg applications and are not suitable to UL Commercial Burg applications. IQ Panel 4 shall use security RF modem radio card model SRF-433AT&T (Digital Life protocol).

SUPPORTED POWER-G SENSORS - NORTH AMERICA



Detector Type	Model
Door/Window	PG9945 ^{UL RF/CB} , PG9307 ^{UL RB} , PG9309, PG9312 ^{UL CB}
Door/Window - Shock Sensor	PG9935 ^{UL CB}
Dual Tech (PIR+Microwave) Motion Detector	PG9984(P) ^{UL CB}
Glassbreak Detector	PG9922 ^{UL CB}
Heat Detector	PG9936H ^{UL RF}
Keyfobs	PG9929, PG9939, PG9949, PG9938 ^{UL CB}
Outdoor Motion Detector	PG9902, PG9974(P), PG9994(P) ^{UL CB}
PIR Motion Detector	PG9904(P), PG9914, PG9924, PG9862, PG9872 ^{UL CB}
PIR Motion Detectors with Camera	PG9934(P), PG9944 ^{UL CB}
Sirens	PG9901 ^{UL RF/RB} , PG9911 ^{UL RF/RB}
Smoke/Heat Detector	PG9936 ^{UL RF}
Wireless CO Detector	PG9933 ^{UL RF}
Wireless Repeater	PG9920 ^{UL CB}
Vanishing Door/Window Contact	PG9303 ^{UL CB} , PG9975 ^{UL RB}
PowerG Wired to Wireless Converter (Supervisory window must be set to 200 sec when used with Fire and/or CO devices)	PG9HRDW8, PG9WLSHW8 ^{UL RFB CB}

NOTE: Only the PowerG sensors marked with ^{UL CB} in the table above shall be used in UL/ULC Residential and Commercial Burg (UL2610/ULC-S304 Security Level I-II) listed installations. Devices marked with ^{UL RB} in the table above shall be used only in UL/ULC Residential Burg (UL1023/ULC-S304 Security Level I) listed installations. Devices marked with ^{UL RF} in the table above can be used in UL/ULC Residential Fire (UL985/ULC-S545) listed installations.

QOLSYS CONFIDENTIAL AND PROPRIETARY

PAGE 195 OF 204

SUPPORTED ZIGBEE SENSORS



Detector Type	Model
Door/Window	SZ-DWS08 ^{UL}
Combo Smoke/Heat/CO	CMB-937 ^{UL}

NOTE: ^{UL} indicates -Use only UL/ULC listed devices for UL/ULC certified installations (UL/ULC Residential Fire and Burglary applications only. Not evaluated for UL/ULC Commercial Burglary applications.

SUPPORTED 868MHz POWER-G SENSORS - UAE

Detector Type	Model
Repeater	RP-600 ME PG2 ^{UL RF}
Smoke Detector	SMD-429 ME PG2 ^{UL RF}
Heat Detector	SMD-429 HEAT PG2, HTD-432 ME PG2 ^{UL RF}

NOTE: ^{UL} indicates Only the PowerG sensors marked ^{UL RF} in the table above are UL listed and shall be used in UL Residential Fire (UL985) listed installations. These devices shall be used only in conjunction with compatible control panel model IQPanel4 ME that includes Bukhoor mode. Model IQPanel4 ME incorporates the PowerG Modem radio card that operates in the 868MHz band. These products are used for applications in UAE. Model IQPanel4 ME is UL listed under UL985 (UTOW) standard.

SPECIFICATIONS - EUROPE & UNITED KINGDOM



Items	Parameters	IQ Panel 4
Platform	Android OS	Android 9
LCD Display	Size	7" (17.8CM) LCD
	Resolution	1280 x 800 pixels
	Brightness	300 cd/m ²
	RGB Color	24bit, 16.9 million colors
Processor	8 Core	Qualcomm SnapDragon 8 Core SOM (System On a Module) with 16 GB of NAND Flash
Touchscreen	Type	Capacitive glass multi-touch
User Codes*	Up to 242	Role based (Dealer, Installer, Master, User, Guest, Duress). For EN50131 certified installations use only 6 digit codes, up to 999.998 combinations of codes available. Codes disallowed 000000 and 000001
Network	WiFi	Wi-Fi 802.11 a/b/g/n/ac dual band 2.4/5ghz - including built-in router capability
	Cellular	LTE CAT4 (Bands 1, 3, 7, 20, 28A, 28B)
Z-Wave Plus 700	Up to 167 Devices	167 total devices (80 lights, 20 Locks, 40 Thermostats, 21 Misc, 6 Garage Doors)
PowerG	Up to 128 devices	868 MHz, long range, secure encrypted two-way wireless
Security RF		Depending on the model; S-Line encrypted 433MHz (Iceland Only)
Bluetooth	Disarming, Audio Streaming	Qualcomm Bluetooth Low Energy (BLE) 4.2
Flash Memory	Internal Storage	16GB NAND Flash
LED Indicator	Status LED	Green (Disarmed), Red (Armed), Triple full color RGB LED. Note: Not enabled for EN50131 certified systems
Speakers/Siren	4w x 4	QuadSound 4x Front Facing 4watt speakers and 85dB siren. Type Z per EN50131-4: internal, self-powered
Camera	Front Camera	8MP wide angle 120° field of view, fixed focus camera with FlexTilt adjustment

*Note: User interface is disabled for 90s after 5 invalid code entries have been made.

SPECIFICATIONS - EUROPE & UNITED KINGDOM



Items	Parameters	IQ Panel 4
Microphone	MEMS x 3	3 MEMs (micro electro mechanical system) Microphones with echo cancellation
Tamper	Tamper Switch	Dual Panel and wall tamper switch with spring release
Battery	Type 18650	Lithium Ion 3.7v/3Ah. Ningbo Veken Battery Co., Ltd, Model VT27 or Icon Energy System Co. Ltd, Model IANO34NA. Low battery threshold: 3.6v and 10% indication for battery capacity
Buttons	Hard Button	Single wake/sleep button used for sleep/wake, hard reboot, and clean screen cancel
Mechanical	Dimension	6.1"H x 7.5"W x 1"D (155mm x 191mm x 26mm)
	Weight	Approximately 1.3 kg
Power Supply	AC/DC External Plug-in Adapter	Output: 7vDC (=) 1500mA CC, Input 230 VAC -10%/+15%, 0.68A, 50Hz (for CE/EN Certified Systems). Current consumption during set & unset procedure: 70mA; quiescent current: 285 mA; max current in alarm mode: 1070 mA. Control Panel and power supply are suitable for installation only within the protected premises.
Standby Time		24h (Battery recharge time [up to 80% of capacity]: 12 h. Energy level of battery in its charged state is 100 %).
Mount	Back Plate	SmartMount wall mount included. SmartMount table stand or SmartMount IQ Base table stand with built-in subwoofer sold separately. For EN 50131 systems only wall mount is allowed.
Certification	Europe	CE & CertAlarm (EN Grade 2): Pending; Denmark: FP -- Reserved; Finland: FFFH:-- Reserved; Norway: FG - Reserved; Sweden: SBSC -- Reserved
	Great Britain	UKCA: Pending. PD 6662 & BS 8243: Pending
Environment		Altitude: Min 0 m to Max 2000m Humidity range: 20% RH to 93% RH (non-condensing) Operating Ambient Temperature: Min -10°C to Max 40°C Storage Ambient Temperature: in -20°C to Max 55°C EN50130-5 Class I - Indoor ordinary location

SUPPORTED POWER-G SENSORS - EUROPE & U.K.



Detector Type	Model
Door/Window	PG8945
Door/Window - Shock Sensor	PG8935
Dual Tech (PIR+Microwave) Motion Detector	PG8984(P)
Glassbreak Detector	PG8922
Heat Detector	PG8936H
Keyfobs	PG8929, PG8938, PG8939, PG8949 Note: AES128 encryption used, Over 1,000,000 combinations of unique identification codes available.
Outdoor Motion Detector	PG8944, PG8974(P), PG8994(P)
PIR Motion Detector	PG8904(P), PG8914, PG8924, PG8934(P)
PIR Motion Detectors with Camera	PG8934(P), PG8944
Sirens	PG8901, PG8911
Smoke Detector	PG8936
Wireless CO Detector	PG8913
Wireless Repeater	PG8920
Vanishing Door/Window Contact	PG8975
PowerG Wired to Wireless Converter	PG8HRDW8, PG8WLSHW8

SUPPORTED 433 MHz SENSORS (ICELAND ONLY - CE COMPLIANT)

Detector Type	Model
Door/Window Sensor	WS4945NA
Motion Detector	WS4904
Motion Detector	WLS914-433
Glass Break Sensor	WLS912L-433
Shock Sensor	EV-DW4927SS
Smoke Detector	WS4936
Carbon Monoxide Detector	WS4933
2 Button Key Fob	WS4949
4 Button Key Fob	WS4939
Pendant Button	WS4938
Wireless Repeater	WS4920

SPECIFICATIONS - LATIN AMERICA (EXCLUDES BRAZIL, COSTA RICA)

Items	Parameters	IQ Panel 4
Platform	Android OS	Android 9
LCD Display	Size	7" (17.8CM) LCD
	Resolution	1280 x 800 pixels
	Brightness	300 cd/m ²
	RGB Color	24bit, 16.9 million colors
Processor	8 Core	Qualcomm Snapdragon 8 Core SOM (System On a Module) with 16 GB of NAND Flash
Touchscreen	Type	Capacitive glass multi-touch
User Codes	Up to 242	Role based (Dealer, Installer, Master, User, Guest, Duress).
Network	WiFi	Wi-Fi 802.11 a/b/g/n/ac dual band 2.4/5ghz - including built-in router capability
	Cellular	LTE CAT4 (Bands 2/25, 4/66, 5/26, 7, 12/17, 13, 14 (non-First Net)
Z-Wave Plus 700	Up to 167 Devices	167 total devices (80 lights, 20 Locks, 40 Thermostats, 21 Misc, 6 Garage Doors)
PowerG	Up to 128 devices	915 MHz, long range, secure encrypted two-way wireless
Security RF		Depending on the model; either S-Line encrypted 319.5MHz, 345MHz or 433MHz
Bluetooth	Disarming, Audio Streaming	Qualcomm Bluetooth Low Energy (BLE) 4.2
Flash Memory	Internal Storage	16GB NAND Flash
LED Indicator	Status LED	Green (Disarmed), Red (Armed), Triple full color RGB LED. Note: Not enabled for EN50131 certified systems
Speakers/Siren	4w x 4	QuadSound 4x Front Facing 4watt speakers and 85dB siren
Camera	Front Camera	8MP wide angle 120° field of view, fixed focus camera with FlexTilt adjustment

SPECIFICATIONS - LATIN AMERICA (EXCLUDES BRAZIL, COSTA RICA)

Items	Parameters	IQ Panel 4
Microphone	MEMs x 3	3 MEMs (micro electro mechanical system) Microphones with echo cancellation
Tamper	Tamper Switch	Dual Panel and wall tamper switch with spring release
Battery	Type 18650	Lithium Ion 3000mAh. Ningbo Veken Battery Co., Ltd, Model VT27 or Icon Energy System Co. Ltd, Model IANO34NA
Buttons	Hard Button	Single wake/sleep button used for sleep/wake, hard reboot, and clean screen cancel
Mechanical	Dimension	6.1"H x 7.5"W x 1"D (155mm x 191mm x 26mm)
Power Supply	AC/DC External Plug-in Adapter	Output: 7vDC (≈) 1000mA CC, or 7vDC (≈) 1.5A CC, Input 100-240VAC 50/60Hz. Adapter evaluated at 120vAC for UL/cUL
Mount	Back Plate	SmartMount wall mount included. SmartMount table stand or SmartMount IQ Base table stand with built-in subwoofer sold separately.
Certification	Argentina	Reserved
	Chile	
	Columbia	
	Uruguay	
Temperature	Operational	0 to 49C, up to 93% relative humidity, indoor, dry ordinary locations use only
	Storage	-20 to 50C

SUPPORTED POWER-G SENSORS - LATIN AMERICA



Detector Type	Model
Door/Window	PG9945, PG9307, PG9309, PG9312
Door/Window - Shock Sensor	PG9935
Dual Tech (PIR+Microwave) Motion Detector	PG9984(P)
Glassbreak Detector	PG9922
Heat Detector	PG9936H
Keyfobs	PG9929, PG9939, PG9949, PG9938
Outdoor Motion Detector	PG9902, PG9974(P), PG9994(P)
PIR Motion Detector	PG9904(P), PG9914, PG9924, PG9862, PG9872
PIR Motion Detectors with Camera	PG9934(P), PG9944
Sirens	PG9901, PG9911
Smoke Detector	PG9936
Wireless CO Detector	PG9933
Wireless Repeater	PG9920
Vanishing Door/Window Contact	PG9303, PG9975
PowerG Wired to Wireless Converter	PG9HRDW8, PG9WLSHW8

Johnson Controls



Qolsys Inc. proprietary.
Reproduction without permission is not permitted.

Document#: IQP4-IM-NA
Version: 1.1.A.2
Revision Date: 2204
Software Version: 4.2.0